

SAMSUNG

SAMSUNG DIGIT^{all}
everyone's invited.™

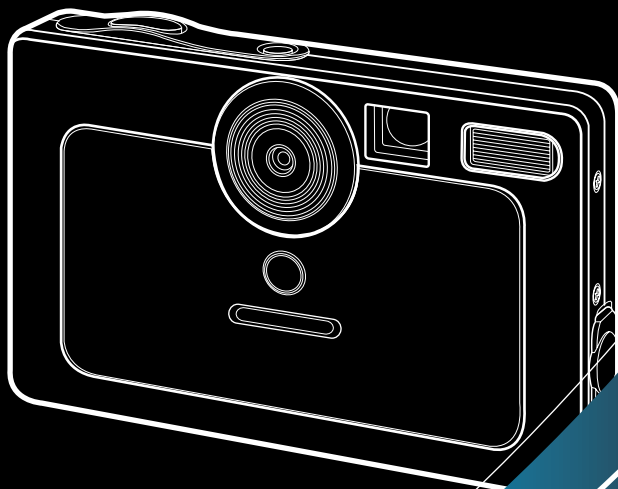

ENGLISH

SAMSUNG CAMERA

User's Manual

Digimax U-CA 401

Thank you for buying a Samsung Camera.

This manual will guide you through using the camera, including capturing images, downloading images and using the application software. Please read this manual carefully before using your new camera.

Instructions

- Use this camera in the following order

Set up the camera driver

Before connecting the camera to a PC, via the USB cable, you will need to set up the camera driver. Install the camera driver that is contained in the Application S/W CD-ROM.(p.75)

Take a picture

Take a picture (p.22)

Insert the USB cable

Insert the supplied USB cable into the PC's USB port and the camera's USB connection terminal.(p.81)

Check the camera's power

Check the camera's power
If the power is turned off, press the camera button to power it on.(p.24)

Check [Removable Disk]

Open Window's EXPLORER and search for [Removable Disk].(p.82)

- If you use a card reader to copy the images on the memory card to your PC, the images could be damaged. When transferring the images taken with the camera to your PC, be sure to use the supplied USB cable to connect the camera to your PC. Please note that the manufacturer holds no responsibility for loss or damage of images on the memory card due to the use of a card reader.

Contents

READY

- Getting to know your camera5
- About the icons5
- Danger6
- Warning6
- Caution7
- An FCC warning7
- This digital camera can be used for8
- Manufacturer's contents10
- Identification of features11
 - Front & Top11
 - Back11
 - Bottom / 5-function button12
 - Mode switch12
 - Function Lamp13
- Connecting to a Power Source14
 - Using the AC power adapter (5V 2.0A) ...15
 - Using the batteries16
 - Removing the battery16
- Precautions on Using the Memory Stick Duo17
- Inserting the memory card19
- Removing the memory card19

RECORDING

- LCD monitor indicator20
- Starting the recording mode21
 - Things to Watch Out for When Taking Pictures23
- Using the camera buttons to adjust the

- camera24
 - POWER button24
 - SHUTTER button24
- ZOOM W button/ ZOOM T button24
- Voice memo/ UP button26
- Macro / Down button (Focusing)26
- Fixed focus27
- FLASH / LEFT button27
- Self-timer / Right button29
- MENU / OK button30
- Play mode / LCD button30
- Using the LCD monitor to adjust the camera31
- How to use the menu33
- Mode33
- Size34
- Quality35
- Metering36
- ISO36
- White balance37
- Effect38
- Shooting38
- Sharpness39
- Exposure40
- Manual Exposure (Night Mode)40

PLAY

- Starting play mode41
 - Playing back a still image41
 - Playing back a movie clip42
 - Playing back a recorded voice42

Contents

●LCD monitor indicator	43	●Function lamp	61
●Using the camera buttons to adjust the camera	44	●Selecting Video out type	62
●Thumbnail/ Enlargement button	44	●Quick view	63
●Voice memo/ Up button	45	●Setting up the MyCAM menu	64
●Delete/ DOWN button	46	●Start up image	64
●LEFT / RIGHT/ MENU/ OK button	47	●Start up sound	65
●LCD button	47	●Shutter sound	65
●Setting up the play back function using the LCD monitor	48	●Important notes	66
●Deleting all images	49	●Warning indicator	68
●Protecting images	49	●Before contacting a service center	69
●Starting the slide show	50	●Specification	71
●Resize	51		
●COPY TO CARD	52		
●DPOF	53		
●DPOF : STANDARD	53		
●DPOF : INDEX	54		
●DPOF : CANCEL	54		

SETUP

●Setup menu	55	●Software Notes	73
●File name	56	●System Requirements	73
●Auto power off	57	●About the software	74
●Language	58	●Setting up the application software	75
●Formatting a memory card	58	●Starting PC Mode	81
●Setting up the Date/ Time/ Date type	59	●Removing the USB Driver for Windows 98SE	84
●Imprinting the recording date	59	●Removable Disk	85
●Sound	60	●Removing the removable disk	86
●LCD brightness	60	■Setting up the USB Driver for MAC	87
●Initialization(RESET ALL)	61	■Using the USB Driver for MAC	87
		●Digimax Viewer 2.1	88
		●Using PhotoImpression	89
		●FAQ	90

SOFTWARE

Getting to know your camera

Thank you for buying a Samsung Digital Camera.

- Prior to using this camera, please read the user manual thoroughly.
 - When you require After Sales service, please bring the camera and the cause of the camera malfunction (such as Batteries, Memory card etc.) to the A/S center.
 - Please check that the camera is operating properly prior to when you intend to use it (e.g. for a trip or an important event) to avoid disappointment. Samsung camera takes no responsibility for any loss or damages that may result from camera malfunction.
 - Keep the manual in a safe place.
- * Microsoft, Windows and Windows logo are registered trademarks of Microsoft Corporation incorporated in the United States and/or other countries.
- * Memory Stick Duo is a registered trademark of Sony Corporation.
- * All brand and product names appearing in this manual are registered trademarks of their respective companies.

About the icons

This manual contains instructions on using this camera that will help you to use this camera safely and correctly. This will help prevent danger and injury to others.



DANGER

DANGER indicates an imminently hazardous situation which, if not avoided, will result in death or serious injury.



WARNING

WARNING indicates a potentially hazardous situation, which, if not avoided, could result in death or serious injury.



CAUTION

CAUTION indicates a potentially hazardous situation, which, if not avoided, may result in a minor or moderate injury.

Danger

- Do not attempt to modify this camera in any way. This may result in fire, injury, electric shock or severe damage to you or your camera. Internal inspection, maintenance and repairs should be carried out by your dealer or Samsung Camera Service Center.
- Please do not use this product in close proximity to flammable or explosive gases, as this could increase the risk of explosion.
- Should any form of liquid or a foreign object enter the camera, do not use it. Switch off the camera, and then disconnect the power source (batteries or AC Power Adapter). You must contact your dealer or Samsung Camera Service Center. Do not continue to use the camera as this may cause a fire or electric shock.
- Do not insert or drop metallic or inflammable foreign objects into the camera through access points e.g. the memory card slot and battery chamber. This may cause a fire or electric shock.
- Do not operate this camera with wet hands. This could pose a risk of electric shock.

DANGER

Warning

- Do not use the flash in close proximity to people or animals. Positioning the flash too close to your subject's eyes, may cause eyesight damage.
- When taking photographs, never point the lens of the camera directly into very strong light. This may result in permanent damage to your eyesight.
- For safety reasons keep this product and accessories out of reach of children or animals to prevent accidents e.g.:
 - Swallowing batteries or small camera accessories. If an accident should occur, please consult a doctor immediately.
 - There is the possibility of injury from the camera's moving parts.
- Batteries and camera may become hot during prolonged use and it may result in camera malfunction. Should this be the case, allow the camera to sit idle for a few minutes to allow it time to cool.
- Do not recharge non rechargeable batteries. This may cause an explosion.
- Do not leave this camera in places subject to extremely high temperatures, such as a sealed vehicle, direct sunlight or other places of extreme variances in temperature. Exposure to extreme temperatures may adversely affect the camera's internal components and could cause a fire.
- When in use, do not cover the camera or AC Power Adapter. This may cause heat to build up and distort the camera body or cause a fire. Always use the camera and its accessories in a well-ventilated area.

Caution

- Leaking, overheating, or burst batteries could result in fire or injury.
 - Use batteries with the correct specification for the camera.
 - Do not short circuit, heat or dispose of batteries in fire.
 - Do not insert the batteries with the reverse polarities.
- Remove the batteries when not planning to use the camera for a long period of time. Batteries may leak corrosive electrolyte and irreparably damage the camera's components.
- Do not fire the flash while it is in contact with hands or objects. Do not touch the flash after using it continuously. It may cause burns.
- Do not move the camera while it is switched on, if you are using the AC Power Adapter. After use, always switch off the camera before unplugging the adapter from the wall socket. Then make sure that any connector cords or cables to other devices are disconnected before moving the camera. Failure to do so may damage the cords or cables and cause a fire or electric shock.

CAUTION

An FCC warning

• This device has been tested in accordance with the limits of a class B digital device under item 15 of the FCC rules. These limits are designed to provide protection against harmful interference in commercial installation. This equipment generates, absorbs and can emit radio frequency energy. If it is not installed and used in accordance with the instructions, it may cause harmful interference to radio communication. There is however, no guarantee that interference will not occur in some situations. Should any interference occur when this device is in operation, please try one or more of the following measures.

- Change the location and direction of any aerial.
 - Increase distance between the camera and the affected device.
 - Use a different socket away from the affected device.
 - Please contact a Samsung agent or a radio/TV engineer.
- This device complies with part 15 of the FCC Rules.
- Changes or modifications not expressly approved by the party responsible for compliance could void user's authority to operate the equipment.

This digital camera can be used for



Printing images using a dedicated printer, DPOF-compatible printer or DPOF-equipped photo lab.
(refer to page 53)



Viewing images on a TV.
(refer to page 62)



Downloading image files from camera to computer.
(refer to page 82)



Taking a picture.
(refer to page 22)



Editing images on a PC.
(refer to page 89)

This digital camera can be used for

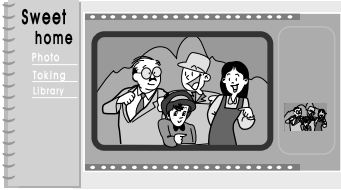

Creation of a digital photo album.

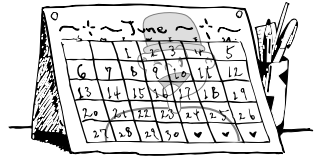

Taking a favourite image and creating your own personalized calendar with it.



Recording your voice.
(refer to page 22)

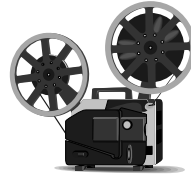

Recording a movie clip
(refer to page 21)

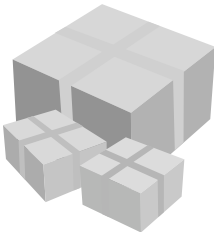

You can even create your own unique gift wrap paper by using your digital images.



Inserting images directly into any electronic document.

Manufacturer's contents

Please check that you have the correct contents before using this product.

 marked contents are optional.

Digital Camera

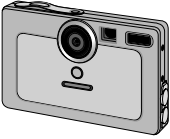

Pouch



AV cable



USB cable



Camera strap



User manual



Product warranty



Software CD



Digimax Reader



Rechargeable battery(SLB-1037)



AC adapter(5V)



Memory Stick Duo

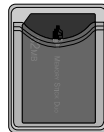

Duracell CP-1 battery

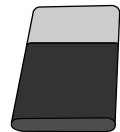

Identification of features

Front & Top

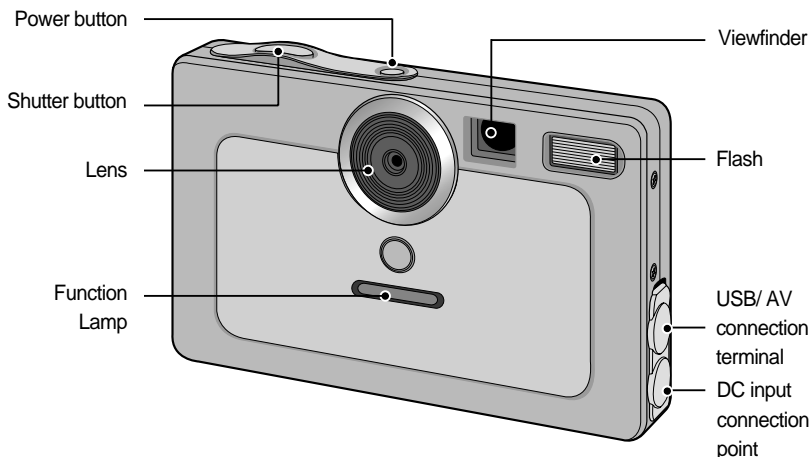

Back

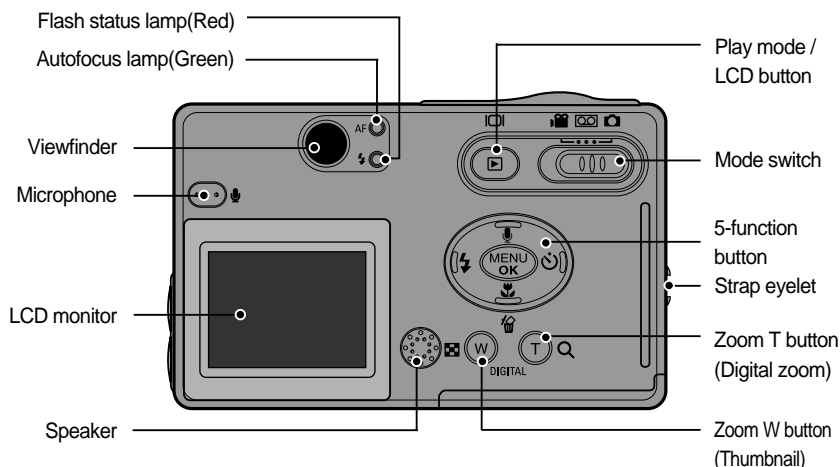

* When using the digital zoom to take a picture, the composition of the picture may be different depending on whether you are using the LCD monitor or the viewfinder. The picture will be taken in the composition of the picture as it appears on the LCD monitor.

Identification of features

Bottom / 5-function button

Battery chamber cover

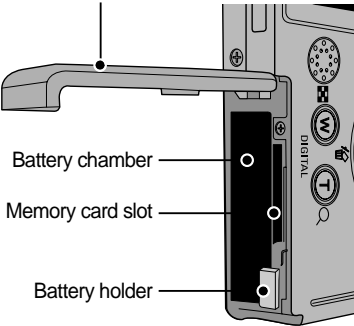

Voice memo/ UP button

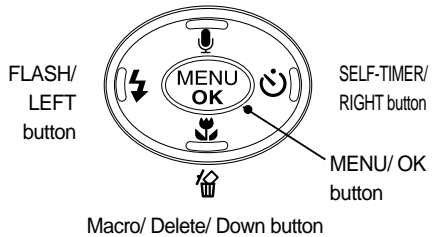

Mode switch

■ You can select the desired working mode by using the mode switch located on the back of the camera. This digital camera has 3 recording modes. These are listed below.

● Movie clip mode

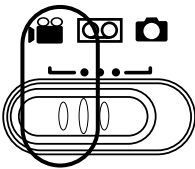

A movie clip can be recorded for as long as the available recording time of the memory capacity allows.

Image size and type are listed below.

- Image size : 640X480, 320X240
(User selectable)
- Movie clip file type : *.avi (MJPEG)

● Voice recording mode

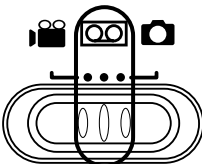

A voice recording can be recorded for as long as the available recording time of the memory capacity allows.

(Max : 1 hour)

Voice recording file type : *.wav

Identification of features

● Still image mode

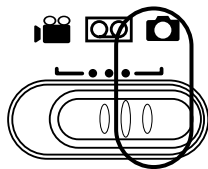

You can select from AUTO(**AUTO**), Night(**🌙**), MYSET(**M**), TEXT(**T**) modes.

Lamp

Type	Function Lamp	Camera Status Lamp	LCD Monitor
When turning on the power	Blue lamp blink and then turns off when the camera is ready to take a picture	Green lamp blinks	X
When the camera is in focus (when the SHUTTER button is pressed halfway)	X	Green lamp lights up	Autofocus mark lights up green
When the camera is out of focus (when the SHUTTER button is pressed halfway)	X	Green lamp blinks	Autofocus mark lights up red
While the flash is charging	X	Red lamp blinks	X
Flash is ready (when the SHUTTER button is pressed halfway)	X	Red lamp lights up	X
While saving an image	X	Green lamp blinks	X
While shooting a video	X	Green lamp blinks	X
During voice recording	The blue lamp blinks in a sequence.	X	X
While the camera is connected to a PC	X	Green lamp lights up	X
While transferring data between the camera and a PC	X	Green lamp blinks	X
When shooting an image	Blue lamp blinks once for 1 second	X	X
While the self-timer is running	When the self-timer is activated, for the first seven seconds, the blue lamp blinks at 1 second intervals. For the final three seconds, the blue lamp blinks rapidly at 0.25-second intervals.	Green lamp lights up	Autofocus mark lights up green
When the LCD monitor is turned off in Still Image mode	X	Green lamp lights up	X

Connecting to a Power Source

- There are two ways in which to provide the camera with power. You can use batteries or alternatively, you can use an AC(100 ~ 250V) Adapter (DC 5V 2.0A).
- We recommend using batteries for a digital camera. (Within a year from the date of manufacture) The batteries are listed below.
 - Non rechargeable batteries : CP-1 battery
 - Rechargeable batteries : Digimax power pack(SLB-1037)
- The product package may vary depending upon which country in which you are located.

■ Charging the rechargeable battery [Digimax power pack (SLB-1037)]

● Charging the battery

- Insert the rechargeable battery into the battery slot of the camera(p.16)
- Use the AC adapter included to connect the power supply of the camera to a wall power socket.

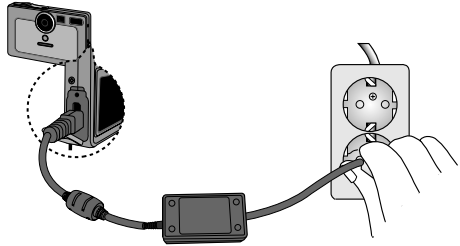

- Following function lamp indicates charging status of the rechargeable battery.

Function lamp display (Blue LED)	One LED blinks	Two LEDs blink	Three LEDs turn on
Charging	0% charged.	About 50% charged.	About 100% charged.

INFORMATION

- If the function lamp display does not work even after inserting the rechargeable battery and connecting the power supply, please double-check the rechargeable battery polarity. (p. 16)
- Please do not connect the AC adapter after inserting a non-rechargeable battery.
- When charging the rechargeable battery using the camera, the working temperature is 5 °C ~ 40 °C. Please note that when the temperature is outside of the optimal charging range, the charging process may become slow or stop.
- When charging the rechargeable battery using the camera, the following sequential blinks of the operational function lamp (BLUE) mean unsuccessful charging process.



Please check whether the battery is correctly inserted and the temperature is within the optimal charging range. If the problem still persists, please visit a nearby service center.

Connecting to a Power Source

INFORMATION

Important information about battery usage

- When the camera is not used, turn off the camera power.
- Please do not charge the non rechargeable battery. It may cause an explosion or fire.
- Please remove the batteries if the camera will not be used for long periods.
- Batteries can lose power over time and are prone to leaking if kept inside the camera.
- Low temperatures (below 0 °C) can affect the performance of the batteries and you may experience reduced battery life.
- Batteries will usually recover at normal temperatures.
- During extended use of the camera, the camera body may become warm. This is perfectly normal.
- If you are planning to use this camera for long periods of time, it is advisable to use an AC adapter (5V 2.0A).

Using the AC power adapter (5V 2.0A)

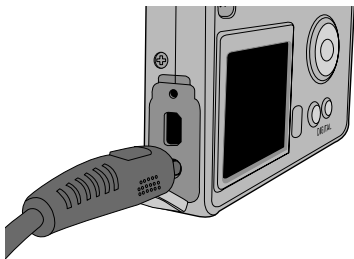

If you have access to a mains supply, using an AC Adapter (5V,2.0A) allows the camera to be used for long periods of time. Plug the adapter into the connection point (DC IN 5V) on the camera. Remove the batteries when using the AC adapter.

DANGER

- Always turn off the power before taking the AC adapter out of the mains supply.
- As with all mains powered devices, safety is important. Ensure that neither the camera nor adapter comes into contact with water or metallic materials.
- Please ensure that you use an AC adapter (5V 2.0A) with the correct specification for the camera. Failure to do so may affect your warranty.

Connecting to a Power Source

Using the batteries

: If the camera does not turn on after you have inserted batteries, please check whether the batteries are inserted with the polarity(+and-)

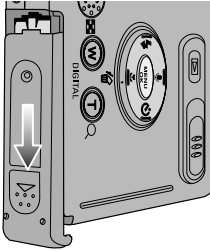

1. Open the battery chamber cover by pushing in the direction of the arrow.

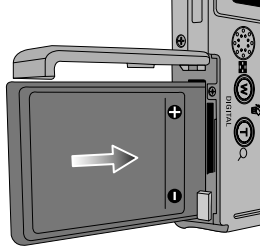

2. Insert the batteries according to the polarity marks (+ and -) on the back of the battery chamber cover.

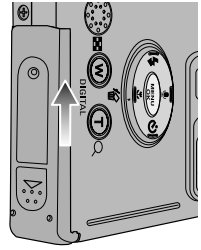

3. To close the battery chamber cover, push it until it clicks.

Removing the battery

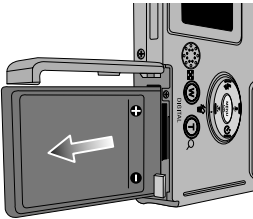

1. Turn off the camera power. Open the battery chamber cover and unlock the battery by pushing the battery lock lever. The battery will pop up slightly.
2. Remove the battery in the direction indicated and close the battery chamber cover.

■ There are 3 indicators for battery condition that are displayed on the LCD monitor.

Battery indicator			
Battery status	The batteries are fully charged.	Prepare new batteries.	There is no battery capacity. Replace with new batteries.

Precautions on Using the Memory Stick Duo

This camera operates only with a Memory Stick Duo.

Some models of Memory Stick Duo media do not have the write-protect switch (B).

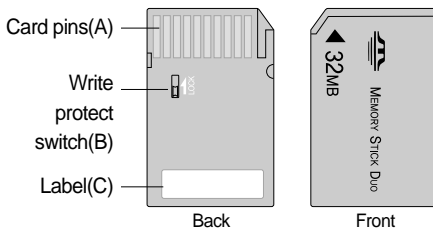

[Memory Stick Duo]

- Do not touch the card pins (part A) with your fingers or with metal objects.
- Do not press hard when writing on the label (part C).
- If you insert the Memory Stick Duo into the Memory Stick Duo adapter, you will be able to use it with a Memory Stick-compatible device.

- Do not insert the Memory Stick Duo on its own into a Memory Stick-compatible device.
- Do not insert the Memory Stick Duo adapter into a Memory Stick-compatible device without attaching the Memory Card Duo to the adapter. Using it without the Memory Stick Duo may adversely affect the device into which it is inserted.
- Be sure to check the proper direction of insertion before use .
- Insert the Memory Stick Duo all the way into the Memory Stick Duo adapter.
If the Memory Stick Duo is not inserted correctly into the adapter, it may not operate properly.
- Do not attach labels to any part of the Memory Stick Duo and Memory Stick Duo adapter.
The labels may come off as you insert the Memory Stick Duo into the adapter or into a Memory Stick-compatible device.
- When inserting the Memory Stick Duo into the slot, do not force or bend it.
- Do not touch the Memory Stick Duo adapter's card pins with your fingers or with metal objects.
- Do not allow dirt or foreign material to get into the Memory Stick Duo adapter slot.
- Do not leave the Memory Stick Duo with its adapter in areas subject to high temperatures.
- Those models with the write-protect switch on the back of the card prevents accidental erasure of data from deletion or formatting. By sliding the switch to the top of the memory card, the data will be protected. By sliding the switch to the bottom of the memory card, the data protection ability will be canceled. Please use a pointed object to move the write-protect switch. Slide the switch to the bottom of the memory card before taking a picture.

Precautions on Using the Memory Stick Duo

■ Maintenance of the Memory Stick Duo

(Hereafter the Memory Stick Duo is referred to as the "Memory Card".)

The camera comes with 32MB of internal flash memory, allowing you to store images and movie clips in the camera. However, you can expand the memory capacity by using an optional memory card so that you can store more images and movie clips.

Be sure to format the memory card (see p. 58) if you are using a newly purchased memory for the first time, if it contains data that the camera cannot recognize, or if it contains images captured with a different camera.

- Turn off the camera power whenever the memory card is being inserted or removed.
- Repeated use of the memory card will eventually reduce the memory card's performance. Should this be the case, you will need to purchase a new memory card. Wear and tear on the memory card is not covered by the Samsung warranty.
- The memory card is an electronic precision device. Do not bend, drop or subject the memory card to any heavy impact.
- Do not store the memory card in an environment with strong electronic or magnetic fields, e.g. near loud speakers or TV receivers.
- Please do not use or store in an environment where there are extremes in temperature.
- Do not allow the memory card to become dirty or to come into contact with any liquid. Should this happen, clean the memory card with a soft cloth.
- Please keep the memory card in its case when not in use.
- During and after periods of extended use, you may notice that the memory card is warm. This is perfectly normal.
- Do not use a memory card that has been used in another digital camera or memory card reader.
- Do not use a memory card formatted by another digital camera or memory card reader.

■ Preserving the memory card data

- Do not remove the memory card while the autofocus lamp(Green) is blinking. Doing so will corrupt the data on the memory card.
- Samsung cannot be held responsible for lost data.
- It is advisable to copy important data onto other media as back-up e.g. floppy disks, hard disks, CD etc.
- If there are no shots remaining
When you press the shutter button, a [CARD FULL !] message is displayed and the camera will not operate. To optimize the amount of memory in the camera, replace the memory card or delete unnecessary images stored in the memory.

Inserting the memory card

1. Turn off the camera power and pull the battery chamber cover in the direction of the arrow to open.

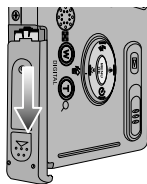

2. Have the front of the memory card face toward the front of the camera (lens) and the card pins toward the back of the camera(LCD monitor), and then push the memory card into the card slot until you hear a click.

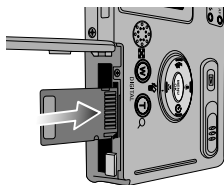

3. To close, push the battery chamber cover until you hear a click. If the memory card does not slide in smoothly, do not attempt to insert it by force. Check the direction of insertion, and then insert it correctly.

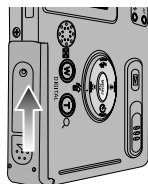

INFORMATION

- Do not insert the memory card the wrong way round . Doing so may damage the memory card slot.

Removing the memory card

1. Turn the power off using the power button.
Open the battery chamber cover and gently push the memory card until it makes a clicking sound. The memory card will pop up slightly.
2. Remove the memory card in the direction indicated and close the battery chamber cover.

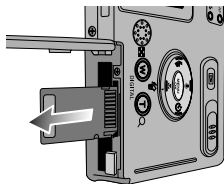

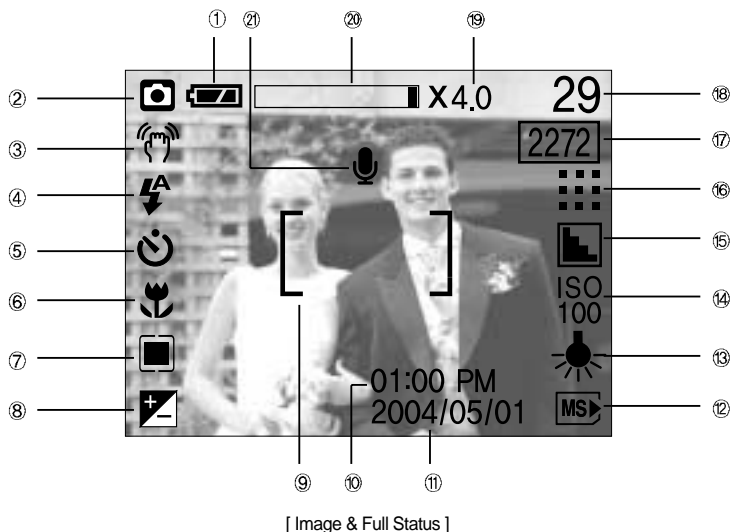

LCD monitor indicator

■ The LCD monitor displays information about the shooting functions and selections.

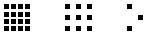
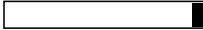

No.	Description	Icons	Page
1	Battery		p.16
2	Recording mode		p.12~13
3	Camera shake warning		p.23
4	Flash		p.28
5	Self-timer		p.29
6	Macro		p.26
7	Metering		p.36
8	Exposure compensation	LT	p.40
9	Auto focus frame	[]	
10	Time	01:00 PM	p.59 ~ 60
11	Date	2004/05/01	p.59 ~ 60
12	MS DUO indicator		p.19
13	White Balance	AWB	p.37
14	ISO	ISO AUTO ISO 100 ISO 200 ISO 400	p.36

LCD monitor indicator

15	Sharpness		p.39
16	Image quality		p.35
17	Image size	2272, 2048, 1600, 1024, 640	p.34
18	Number of available shots remaining	29	
	Remaining time (Movie clip/Voice recording)	00:01:50 / 01:00:00	p.21 ~ 22
19	Digital Zoom rate	X4.0	p.25
20	Digital Zoom		
21	Voice memo		p.26

Starting the recording mode

- If the memory card is inserted in the camera, all the camera functions apply only to the memory card.
- If the memory card is not inserted in the camera, all the camera functions apply only to the internal memory.

■ Recording a Movie clip

1. Insert the batteries (p.16). Insert the batteries taking note of the polarity (+ / -).
2. Insert the memory card (p.19). As this camera has a 32MB internal memory, you do not need to insert the memory card. If the memory card is not inserted, an image will be stored in the internal memory. To expand memory capacity, insert a memory card. If the memory card is inserted, an image will be stored on the memory card.
3. Close the battery chamber cover.
4. Press the power button to turn on the camera.
5. Select the MOVIE CLIP () mode by sliding the mode switch.
6. Point the camera towards the subject and compose the image by using either the viewfinder or LCD monitor.
7. Press the shutter button to take a movie clip.
Press the shutter button once and movie clips are recorded for as long as the available recording time allows. Movie clips will still be recorded if the shutter button is released. If you wish to stop recording, press the shutter button again.

Image size and type are listed below.

- Image size : 640X480, 320X240(Selectable)
- File type : *.avi(MJPEG)

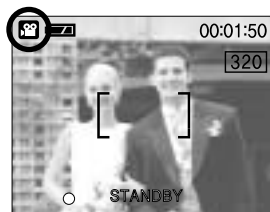
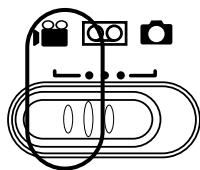

[MOVIE CLIP mode]

Starting the recording mode

■ Recording Voice

Steps from 1-4 are the same as those for recording a movie clip.

5. Select the VOICE RECORDING() mode by sliding the mode switch.

6. Press the shutter button to record a voice.

- Press the shutter button once and voice is recorded for as long as the available recording time(Max:1hour) allows. The recording time will be displayed on the LCD monitor.

- Voice will still be recorded if the shutter button is released.

- If you wish to stop recording, press the shutter button again.

- Voice recording file type: *.wav

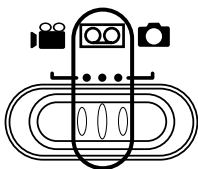

[VOICE RECORDING mode]

INFORMATION

- A distance of 40cm between you and the camera (microphone) is the best distance to record sound.

■ Recording a still image

Steps from 1-4 are the same as those for recording a movie clip.

5. Select the STILL IMAGE() mode by sliding the mode switch.

6. Point the camera towards the subject and compose the image by using either the viewfinder or LCD monitor.

7. Press the shutter button to capture an image.

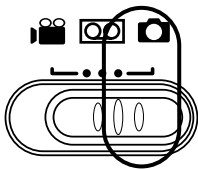

[STILL IMAGE mode]

Things to Watch Out for When Taking Pictures

■ Pressing the shutter button down half way

Lightly press the shutter button to confirm focus and flash battery charge. (See page 13) Press the shutter button all way down to take the picture.

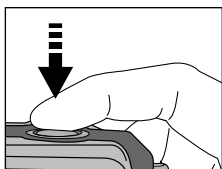

[Lightly press the shutter button]

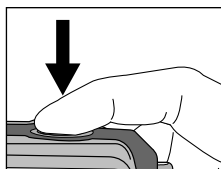

[Press the shutter button]

- The available recording time may vary depending on shooting conditions and camera settings.
- When the Flash Off or Slow synchro mode is selected in a low lighting condition, the camera shake warning indicator () may appear on the LCD monitor. In this case, change the flash mode to flash shot mode.
- Backlight compensated shots : When taking an outdoor shot, avoid facing the sun, as the image may be dark because of the strong backlight. In backlight conditions, please use Fill-in flash(p.28), Spot metering(p.36) or Exposure compensation(p.40).
- Avoid obstructing the lens or the flash when you capture an image.
- As there can be some differences between what is seen through the Viewfinder and the resulting image when taken at a range closer than 1.5m, it is recommended that you use the LCD monitor to compose these shots.
- Using the LCD monitor extensively will drain the batteries.
We recommend turning off the LCD monitor and using the optical viewfinder as often as possible in order to extend battery life.
- Under certain conditions the auto focus system may not perform as expected.
 - When photographing a subject that has little contrast.
 - If the subject is highly reflective or shiny.
 - If the subject is moving at high speed.
 - When there is strong reflected light, or when the background is very bright.
 - When the subject matter has only horizontal lines or the subject is very narrow (such as a stick or flagpole).
 - When the surroundings are dark

Using the camera buttons to adjust the camera

- The RECORDING mode function can be set up by using the camera buttons.

POWER button

- Used for turning the camera's power on / off.
- If there is no operation during the specified time, the camera's power will be turned off automatically to save battery life.

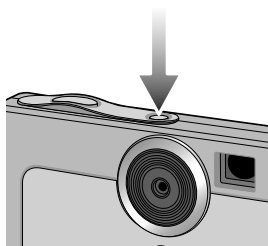

SHUTTER button

- Used for taking an image or recording voice in the RECORDING (STILL IMAGE, VOICE RECORDING, MOVIE CLIP) mode.
- In MOVIE CLIP mode :
Pressing the shutter button down fully starts the process for recording a movie clip. Press the shutter button once and the movie clip is recorded for as long as the available recording time in the memory allows. If you wish to stop recording, press the shutter button again.
- In STILL IMAGE mode
Pressing the shutter button down halfway activates the autofocus and checks the condition of the flash.
Pressing the shutter down fully takes the image and stores the relevant data regarding the shot. If you select voice memo recording, the recording will start after storing the image data is complete.

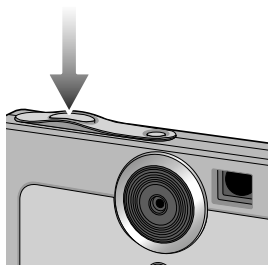

ZOOM W button/ ZOOM T button

- Used for digital zooming in / out.
- When you press the ZOOM W/T button, the zoom bar will display in the upper center part of the LCD monitor.



ZOOM W button/ ZOOM T button

● TELE Zoom

Digital zoom TELE

: Pressing the ZOOM button T activates the digital zoom software. Releasing ZOOM T button stops the digital zooming at the required setting. Once the maximum digital zoom (4X) is achieved, pressing the ZOOM T button will have no effect. You can check the digital zoom rate with the [X1.1 ~ X 4.0] numerical mark next to the zoom bar.

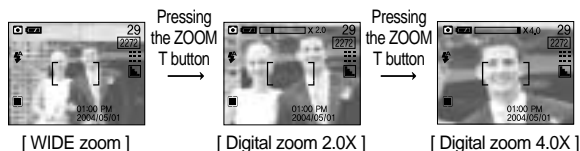
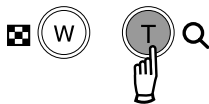

● WIDE Zoom

Digital zoom WIDE

: Pressing the zoom W button will reduce the digital zooming in steps. Releasing zoom button W stops digital zooming.

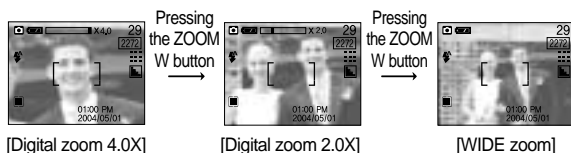
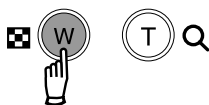

INFORMATION

- To use the digital zoom the LCD monitor has to be turned on.
- Images taken using the digital zoom may take a little longer for the camera to process. Allow time for this to take place.
- The digital zoom cannot be used in movie clip shots.
- You may notice a decrease in image quality when using the digital zoom.

Voice memo(🎤)/ UP button

- While the menu is showing, press the UP button to move up the submenu cursor.
- When the menu is not displayed on the LCD monitor, the UP button operates as the voice memo button. You can add your voice-over to a stored still image.
- Recording a voice memo
 1. Select the STILL IMAGE mode by sliding the mode switch.
 2. Press the VOICE MEMO button. If the voice memo indicator is displayed on the LCD monitor, the setting is completed.

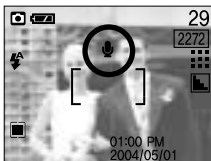

[Preparing for Voice Memo]

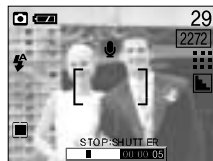

[Recording Voice Memo]

3. Press the shutter button and take a picture. The picture is stored on the memory card.
4. Voice memo will be recorded for ten seconds from the moment the picture is stored. In the middle of the sound recording, pressing the shutter button will stop the voice memo.

Macro(🌸) / Down button (Focusing)

- While the menu is showing, press the DOWN button to move from the main menu to a submenu, or to move down the submenu cursor.
- When the menu is not showing, you can use the MACRO (🌸)/DOWN button to take macro pictures in the 6 ~ 60cm STILL IMAGE mode.

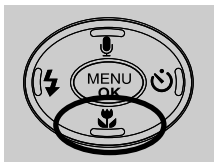

[Autofocus]

Pressing the
MACRO button



[Macro]

INFORMATION

- When the macro mode is selected, it is possible that camera shake will occur. If this is the case, use a tripod to eliminate this.
- When the macro mode is selected, it is recommended that you use the LCD monitor to compose these shots.

Fixed focus

- To focus on the subject positioned outside of the center, use the focus lock function.
- Using the Focus Lock
 1. Ensure the subject in the center of the autofocus frame.
 2. Press the SHUTTER button halfway. When the autofocus lamp (green) lights up, it means the camera is focused on the subject. Be careful not to press the SHUTTER button all the way down to avoid taking an unwanted picture.
 3. With the SHUTTER button still pressed down only halfway, move the camera to recompose your picture as desired, and then press the SHUTTER button completely to take the picture. If you release your finger from the SHUTTER button, the focus lock function will be canceled.

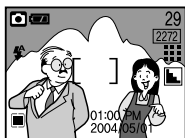

[The image to be captured]

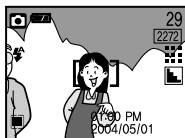



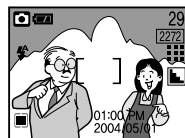

[Press the SHUTTER button halfway and focus on the subject]



[Recompose the picture and fully depress the SHUTTER button]

FLASH() / LEFT button

- When the menu is displayed on the LCD monitor, pressing the LEFT () button makes the cursor shift to the left tab.
- When the menu is not displayed on the LCD monitor, the LEFT () button operates as the FLASH () button.
- Selecting the flash mode
 1. Slide the mode switch to the STILL IMAGE mode.
 2. Press the Flash() button until the desired flash mode indicator displays on the LCD monitor.
 3. A flash mode indicator will be displayed on the LCD monitor.
Use the correct flash to suit the environment.









[Selecting the Auto flash]

- Flash range(AUTO) : 0.2 ~ 2m

FLASH(⚡) / LEFT button

- Flash mode indicator

ICON	Flash mode	Description
	Auto flash	If the subject or background is dark, the camera flash will operate automatically.
	Red eye reduction	If a subject or background is dark, the camera flash will work automatically and will reduce the red-eye effect by using the red-eye reduction function.
	Fill in flash	The flash fires regardless of available light. The intensity of the flash will be controlled, according to the prevailing conditions. The brighter the background or subject is, the less intense the flash will be.
	Slow synchro	The flash will operate in conjunction with a slow shutter speed in order to obtain the correct exposure. When you take an image in a condition with poor light, the camera shake warning indicator () will display on the LCD monitor.
	Flash off	The flash does not fire. Select this mode when capturing images in a place or situation where flash photography is prohibited. When you capture an image in a poorly lit condition, the camera shake warning indicator () will display on the LCD monitor.

INFORMATION

- Using the flash frequently will reduce the life of the batteries.
- Under normal operating conditions the charging time for the flash is normally within 5 seconds. If the batteries are weak, the charging time will be longer.
- During the movie clip mode, the flash function will not operate.
- Take photographs within the flash range.
- The image quality is not guaranteed if the subject is too close or highly reflective.
- The LCD monitor is turned off for a while after using the flash to recharge it.

Self-timer(☺) / Right(▶) button

- When the menu is displayed on the LCD monitor, pressing the Right button makes the cursor shift to the sub tab.
- When the menu is not displayed on the LCD monitor, the RIGHT button operates as the Self-timer(☺) button. This function is used when the photographer would also like to be in the image.

● Selecting the self-timer

1. Slide the mode switch to the STILL IMAGE mode.
2. Press the SELF-TIMER button until the desired mode indicator displays on the LCD monitor.

A 10 second, 2 second or Double self-timer icon appears on the LCD monitor.

· 10SEC self-timer (☺) :

Pressing the shutter button will allow an interval of 10 seconds before the image is taken.

· 2SEC self-timer (☺^{2S}) :

Pressing the shutter button will allow an interval of 2 seconds before the image is taken.

· Double self-timer (☺^{DS}) :

A picture will be taken after about 10 seconds and 2 seconds later a second picture will be taken. When using the flash, the 2-second self-timer may be delayed for longer than 2 seconds depending on the flash charge time.

3. When you press the SHUTTER button, the picture will be taken after the specified time has elapsed.

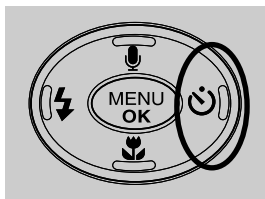

[Selecting the 10SEC self-timer]

INFORMATION



- The default is OFF.
- When taking a picture using the self-timer, the function lamp works as follows:
 - 10 second self-timer setting : The function lamp blinks at 1 second interval for the first 7 seconds. It blinks at 0.25 second interval for the remaining 3 seconds.
 - 2 second self-timer setting : The function lamp blinks at 0.25 second interval for 2 seconds.
- If you operate the Power button, Mode switch, and Self-timer button during the self-timer operation, the self-timer function is cancelled.
- The only self-timer option available during the recording of a movie clip is the 10 second option. When in the voice recording mode and TEXT mode, the self-timer function does not work.

MENU/ OK button

- If the menu is displayed, use the 5-Function buttons to change the data values and for your changes to be accepted
- If the menu is not displayed, press the MENU/OK button to display a menu for the current camera mode on the LCD monitor. Press the button again to return to the previous state.



Play mode() / LCD button

- Press and hold the Play mode / LCD() button for 2 seconds to play pictures saved in the memory
- Press (but do not hold down) the Play mode / LCD() button while playing saved pictures to see the current image information in the LCD
- Repeatedly press (but do not hold down) the Play mode / LCD() button in the Normal mode to display the further information in the LCD.

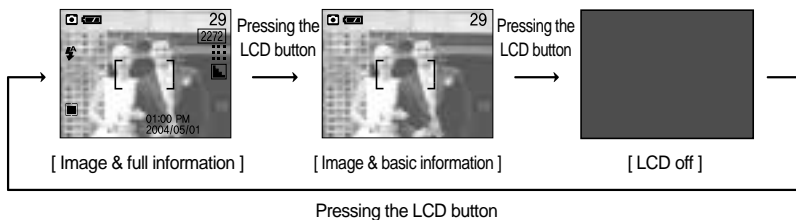
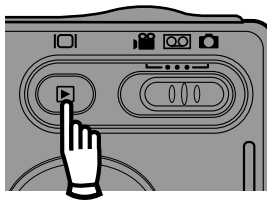

Using the LCD monitor to adjust the camera















- You can use the menu on the LCD monitor to set up recording functions.

INFORMATION

























- The menu will not be displayed on the LCD monitor in the following circumstances:
 - When another button is being operated.
 - While image data is being processed. (when the autofocus lamp next to the viewfinder blinks)
 - When there is no battery capacity.
- When the menu is showing on the LCD monitor, it is not possible to operate the shutter button i.e. capture an image. To capture an image, simply cancel the menu display by pressing the MENU button.

- The following functions are available, depending on the mode you have selected.

The items indicated by  are default settings.

Menu tab	Main menu	Sub menu	Camera working mode
	MODE	AUTO	   
		NIGHT	
		MySET	
		TEXT	
	SIZE	2272X1704	  
		2048X1536	
		1600X1200	
		1024X768	
		640X480	
		640X480	
320X240			
	QUALITY	S. FINE	  
		FINE	
		NORMAL	

Using the LCD monitor to adjust the camera

Menu tab	Main menu	Sub menu	Camera working mode	
	METERING	MULTI	 	
		SPOT		
	ISO	AUTO	 	
		100		
		200		
		400		
	WHITE BALANCE	AUTO	  	
		DAYLIGHT		
		CLOUDY		SUNSET
		FLUORESCENT		TUNGSTEN
	EFFECT	NORMAL	  	
		B & W		
		SEPIA		
	SHOOTING	SINGLE	 	
		CONTINUOUS		
		AEB		
	SHARPNESS	SOFT	 	
		NORMAL		
		VIVID		
	EXPOSURE	+2.0EV ~ +0.0EV ~ -2.0EV	 	
	MANUAL	AUTO		
	EXPOSURE	1/8, 1/4, 1/2, 1, 2, 4, 8 SEC		

How to use the menu

1. Turn on the camera and press the MENU button. A menu for each camera mode appears. However, there is no menu for Voice Recording mode ().
2. Use the LEFT and RIGHT buttons to navigate through the menus.

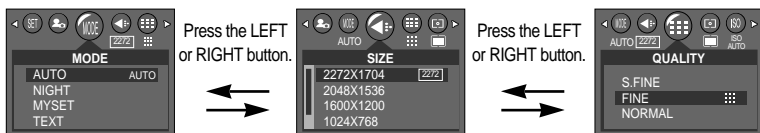





3. Use the UP and DOWN buttons to select a sub menu.



4. Select a sub menu, and then press the OK button.
The value you set will be saved and the menu will disappear.

Mode

- You can select the desired Still Image mode.

AUTO		: Use this for shooting basic still images.
NIGHT		: Use this for shooting still images at night or in other dark conditions.
MYSET		: Use this to store your custom settings for the camera. Any changes made to settings other than Self-Timer and Voice Recording will be saved.
TEXT		: Use this mode to shoot a document.



[STILL IMAGE mode]

Mode

INFORMATION

- In the Text mode, the camera uses the macro-shooting mode, and the flash function does not work.
- An image captured in the TEXT mode can be changed as text file type by using the Digimax Reader. For detailed instruction on how to use Digimax Reader, please refer to the program's Help.

Size

- You can select the image size appropriate for your application.

Mode	STILL IMAGE mode					MOVIE CLIP mode	
Icon	2272	2048	1600	1024	640	640	320
Size	2272x1704	2048x1536	1600x1200	1024x768	640x480	640x480	320x240

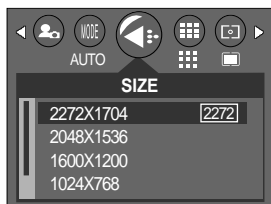

[STILL IMAGE mode]



[MOVIE CLIP mode]

- Fixed as [2272X1704] in the TEXT mode.

INFORMATION

- The higher the resolution, the lower the remaining shots will be because high resolution images require more memory than lower resolution images.

Quality

- You can select the compression ratio appropriate for your application of the captured images. The higher the compression ratio, the lower the picture quality.

Mode	STILL IMAGE mode		
Icon			
Sub menu	S.FINE	FINE	NORMAL
File Format	jpeg	jpeg	jpeg



[STILL IMAGE mode]

- Fixed as [FINE] in the TEXT mode.
- Image Size and Quality for the Number of Images that can be saved in a Memory Card.
(When using a 32MB internal memory; based on Samsung's own testing)

Mode	STILL IMAGE mode				
Quality/Size	2272	2048	1600	1024	640
S.FINE	14	16	29	67	159
FINE	28	35	58	142	306
NORMAL	43	53	80	165	360

INFORMATION

- S.FINE is the highest quality and NORMAL is the lowest setting. Choose the setting appropriate for your needs.
- This file format complies with the DCF (Design rule for Camera File system).
- Even if the camera should be restarted, the quality setting is maintained.
- JPEG (Joint Photographic Experts Group): JPEG is the image compression standard developed by the Joint Photographic Experts Group. This type of compression is most commonly used for compressing photos and graphics because it can compress the files efficiently without damaging the data.

Metering

- If you cannot obtain suitable exposure conditions, you can change the metering method to take brighter pictures.

MULTI () : Exposure will be calculated based on an average of the available light in the image area. However, the calculation will be biased towards the centre of the image area. This is suitable for general use.

SPOT () : Only the rectangular area in the center of the LCD monitor will be metered for light. This is suitable when the subject in the center is exposed correctly, regardless of the back lighting.

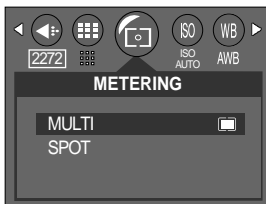

- Fixed as [MULTI] in the TEXT mode.

INFORMATION

- The default metering mode is Multi pattern metering.
- If the subject is not the centre of the focus area, do not use the spot metering as this may result in an exposure error. In this circumstance, rather use exposure compensation.

ISO

- You can select the ISO sensitivity when taking pictures.
- The speed or specific light-sensitivity of a camera is rated by ISO numbers.
- The higher the ISO value, the higher the camera's sensitivity to light is and therefore the greater its capacity to take pictures in dark conditions. However, the noise level in the image will increase as the ISO value increases, making the image appear coarse.

● ISO

- AUTO :

The camera's sensitivity is automatically changed by variables such as lighting value or subject brightness.

- 100, 200, 400 :

You can increase the shutter speed while the same amount of light is present, by increasing the ISO sensitivity. However, the image may be saturated in high luminance.



[STILL IMAGE mode]

- Fixed as [100] in the TEXT mode.

White balance

- White balance : The white balance control allows you to adjust the colours to appear more natural looking.

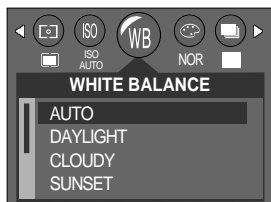



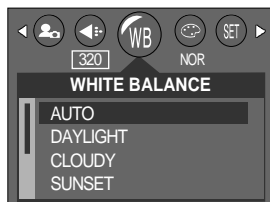

[STILL IMAGE mode]



[MOVIE CLIP mode]

● White balance

- AUTO : The camera automatically selects the appropriate white balance settings, depending on the prevailing lighting conditions.
- DAYLIGHT  : For taking images outside.
- CLOUDY  : For taking images under a cloudy and overcast sky.
- SUNSET  : For taking images at sunset.
- TUNGSTEN  : For shooting under tungsten (standard light bulb) lighting.
- FLUOR.  : For shooting under fluorescent lighting.

- Fixed as [AUTO] in the TEXT mode.

Effect

- By using the camera's digital processor, it is possible to add special effects to your images. The value you set will remain unchanged until the camera is turned off.

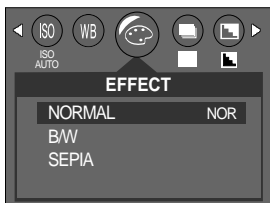

[STILL IMAGE mode]

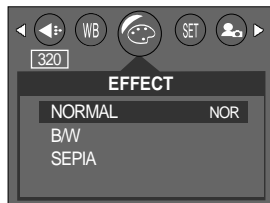

[MOVIE CLIP mode]

NORMAL : No effect is added to the image.

B & W : Converts the image to black and white.

SEPIA : Captured images will be stored in a sepia tone (a gradient of yellowish brown colours).

- Fixed as [NORMAL] in the TEXT mode.

Shooting

- You can select continuous shooting or AEB(Auto Exposure Bracket) shooting in this menu.
- If you select CONTINUOUS or AEB, the flash will automatically be set to Flash Off.

● Shooting

- SINGLE: A picture will be taken each time you press the Shutter button.

- CONTINUOUS: Press and hold the shutter button, and images are captured continuously. This can be used for taking a moving subject. Use this to take pictures of moving objects/people.

* Five continuous shots are supported regardless of resolution and image quality. If more than five images are made, the subsequent shots will be saved as normal image quality.

- AEB : 3 pictures will be taken continuously, 1 underexposure (-0.5EV), 1 normal exposure (+0.0EV), and 1 overexposure (+0.5EV) respectively. However, the actual image files saved from the three AEB exposures are saved as normal quality.

- Fixed as [SINGLE] in the TEXT mode.



Sharpness

- You can adjust the sharpness of the picture you want to take. You cannot check the sharpness effect on the LCD monitor before you take a picture, because this function is applied only when the captured image is stored on the memory.



[STILL IMAGE mode]

Sub menu	Icon	Description
SOFT		The edges of the image are softened. This effect is suitable for editing images on your PC.
NORMAL		The edges of the image are sharp. This is suitable for printing.
VIVID		The edges of the image are emphasized. The edges will appear sharp, but noise may occur in the recorded image.

- Fixed as [VIVID] in the TEXT mode.

Exposure

- The camera automatically adjusts the exposure depending on external conditions such as lighting levels. However, the user can also choose to manually set the exposure.
- Fixed as [+0.0EV] in the TEXT mode.

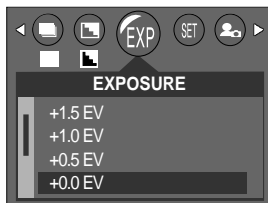

INFORMATION

- Increase the exposure to brighten the picture, and decrease the exposure to darken the picture.
- A negative exposure compensation value reduces the exposure. Note that a positive exposure compensation value increases the exposure and the LCD monitor will appear white or you may not get good pictures.
- -2.0EV ~ +2.0EV (0.5EV steps) exposure levels are supported.
- If you change the exposure value, the exposure indicator () will be displayed on the bottom of the LCD monitor.
- The exposure value returns to +0.0EV when the power is turned on again.

Manual Exposure (Night Mode)

- Whilst the camera automatically adjusts the best shutter speed and iris values according to the situation, the user can manually set the shutter speed in Night Scene mode.
- Configuring manual exposure (LT: Long Time Shutter)
 1. Press the menu button in normal camera mode to select the Night Scene mode.
 2. Use the Left/Right buttons to select the manual exposure tab.
 3. Use the Up/Down buttons to set the shutter speed.
 - Supported shutter speeds: 1/8, 1/4, 1/2, 1, 2, 4, 8 seconds
 4. Press the OK button to confirm and close the menu. After setting the manual exposure, the manual exposure indicate icon (**LT**) is displayed in the lower left of the LCD.

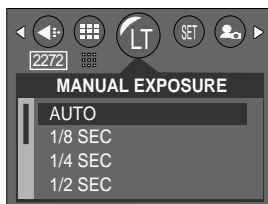

Starting play mode

- If the memory card is inserted in the camera, all the camera functions apply only to the memory card.
- If the memory card is not inserted in the camera, all the camera functions apply only to the internal memory.
- Press and hold the play mode button for 2 seconds to select play mode. The camera plays images saved in the memory card.
- If the power is turned on with the power button, press and hold the play mode button for 2 seconds to select play mode. Press and hold the play mode button for 2 seconds again to select shooting mode. If the power is turned on with the play mode button, press and hold the play mode button for 2 seconds to select shooting mode from play mode.
- You can set up the PLAY mode function by using the camera buttons and LCD monitor.

● Playing back a still image

1. Press and hold the play mode button for 2 seconds to select play mode.

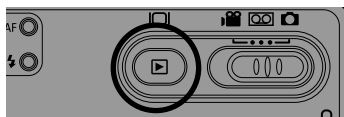

2. The last image stored on the memory is displayed on the LCD monitor.



3. Select an image that you want to play back by pressing the LEFT / RIGHT button.

- ※ Press and hold the LEFT or RIGHT button to play back the images quickly.

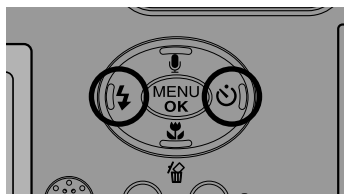

INFORMATION

- Even if the camera's power is off, you can start the play mode by pressing the play mode button.

Starting play mode

■ Playing back a movie clip

Steps from 1-2 are the same as those to play back a still image.

3. Select the recorded movie clip that you want to play back by using the LEFT/RIGHT button. If you select a movie clip, the movie clip indicator () will be displayed on the LCD monitor.
4. Press the shutter button to play back a movie clip file.
 - To pause a movie clip while playing it back, press the shutter button again.
 - Pressing the shutter button again will cause the movie clip file will restart.
 - To rewind the movie clip while it is playing, press the LEFT button. To fast forward the movie clip, press the RIGHT button.
 - To stop playback of the movie clip, press the shutter button, and then press the LEFT or RIGHT button.



■ Playing back a recorded voice

Steps from 1-2 are the same as those to play back a still image.

3. Select the recorded voice that you want to play back by using the LEFT/RIGHT button. If you select a recorded voice file, the voice indicator () will be displayed on the LCD monitor.
4. Press the shutter button to play back a recorded voice file.
 - To pause a recorded voice file, while playing it back, press the shutter button again.
 - To resume playback of the voice file, press the shutter button.
 - To stop playback of the voice file, press the shutter button, and then press the LEFT or RIGHT button.

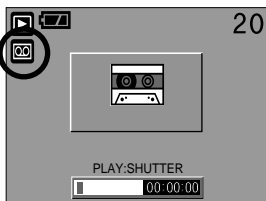

LCD monitor indicator

- The LCD monitor displays information about the shooting conditions.



No.	Description	Icon	Page
1	Battery		p.16
2	Play mode		
3	File Type		
4	Protect indicator		p.49 ~ 50
5	Voice memo		p.45 ~ 46
6	DPOF indicator		p.53
7	Stored image number	9	

- If you press the LCD button, you can check the following recording information.

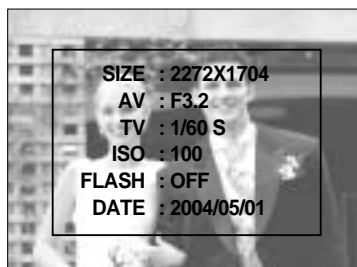

SIZE	: 2272X1704	Size
AV	: F3.2	Aperture value
TV	: 1/60 S	Shutter speed
ISO	: 100	ISO sensitivity
FLASH	: OFF	Whether or not the flash is used.
DATE	: 2004/05/01	Recording date

Using the camera buttons to adjust the camera

- In Play mode, you can use the buttons on the camera to conveniently set up the Play mode functions.

Thumbnail() / Enlargement() button



- You can view multiple pictures, enlarge a selected picture, and crop and save a selected area of an image.

● Thumbnail display

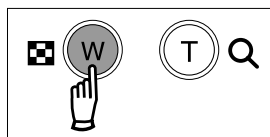
1. While an image is displayed full screen, press the thumbnail button.
2. The thumbnail display will highlight the image that had been showing at the time the thumbnail mode was selected.
3. Press the 5 function button to move to a desired image.
4. To view an image separately, press the enlargement button ().



[Normal display mode]

Pressing the thumbnail
button()
←→
Pressing the enlargement
button()
→

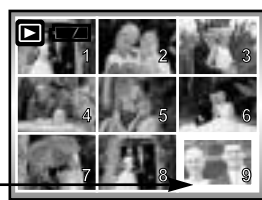

[Thumbnail display mode]

● Image enlargement

1. Select an image that you want to enlarge and press the enlargement button.
2. Different parts of the image can be viewed by pressing the 5 function button.
3. Pressing the thumbnail button will zoom back to the original full sized image.
 - You can tell whether the image displayed is an enlarged view by checking the image enlargement indicator shown at the bottom left of the LCD monitor. (If the image is not an enlarged view, the indicator will not be displayed.) You can also check the area of enlargement.
 - Movie clips and WAV files can't be enlarged.
 - If an image is enlarged, a loss of quality may occur.

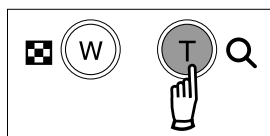

Thumbnail () / Enlargement() button

● When playing, 8X zoom is available regardless of the image resolution.

● Trimming : You can extract part of the image that you want and save it separately.

1. Select an image that you want to enlarge and press the enlargement button.

2. Different parts of the image can be viewed by pressing the 5 function button.

3. Press the MENU button and a message will be displayed as shown alongside.

4. Press the OK button to save the trimmed image with a new file name.

The trimmed image will be displayed on the LCD monitor.

Press the LEFT button to return to the image before it was selected.

- If there is little memory space to save the trimmed image, the image can't be trimmed.

- An image can't be trimmed under 160X120 image size.



Voice() memo / Up button

■ When the menu is displayed on the LCD monitor, pressing the UP button makes the menu cursor move up.

■ When the menu is not displayed on the LCD monitor, the UP button operates as the voice memo button. You can add your audio to a stored still image.

● Adding a Voice Memo to a Still Image

1. Press the LEFT/ RIGHT button to select an image that you wish to add sound to.

2. Press the VOICE MEMO() button. If the voice memo indicator is displayed on the LCD monitor, the setting is completed.

3. Press the shutter button to insert a 10-second voice memo in the playing image.



Voice(🎤) memo / Up button

- The recording can be stopped by pressing the shutter button again.
- The (🎵) icon will be displayed on the LCD monitor after voice memo recording has finished.
 - Voice memos can't be recorded onto movie clip files.
 - A distance of 40cm between you and the camera (microphone) is the best distance to record sound.
 - The voice memo will be saved in *.wav format, but has the same file name as the still image to which it corresponds.
 - If you add a new voice memo to the still image that already has a voice memo, the existing voice memo will be erased.



Delete(🗑️)/DOWN button

■ This deletes images stored on the memory card.

● Deleting Images in Play Mode

- Select an image that you want to delete by pressing the LEFT / RIGHT button and press the DELETE(🗑️) button.
- A message will display as shown alongside on the LCD monitor.
- Press the OK button to delete the image. The image that precedes the deleted one will then be displayed on the LCD monitor.

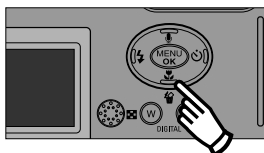

INFORMATION

- When using thumbnail mode, the Delete (🗑️) button functions as the Down button. You will not be able to delete an image with the Delete button.
- Before deleting images from the camera, you should protect or download images to your computer that you wish to keep.

LEFT / RIGHT/ MENU/ OK button

■ LEFT / RIGHT/ MENU/ OK buttons activate the following.

- LEFT button : While the menu is showing, press the LEFT button to select the menu tab to the left of the cursor.
- RIGHT button : While the menu is showing, press the RIGHT button to select the menu tab to the right of the cursor, or to move an auxiliary menu.
- MENU button : When you press the MENU button, the play mode menu will be displayed on the LCD monitor. Pressing it again will return the LCD to the initial display.
- OK button : When the menu is displayed on the LCD monitor, the OK button is used for confirming data that is changed by using the 5 function button.

LCD button

■ The shooting information will be displayed on the LCD monitor.

Press and hold the Play (▶) button for 2 seconds to display the last taken picture in the LCD.

Pressing the LCD button in the PLAY (▶) mode will change the display as shown below. [Image & Icons] → [Image & Information] → [Image only]

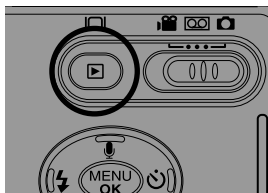

[Image & Icons]

Pressing
the LCD
button

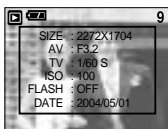

[Image & Information]

Pressing
the LCD
button









[Image only]

Pressing the LCD button

Setting up the play back function using the LCD monitor

■ PLAY mode functions can be changed by using the LCD monitor. In the PLAY mode, pressing the MENU button displays the menu on the LCD monitor. The menus you can set up in Play mode are as follows. Press and hold the Play mode button for 2 seconds to return to shooting mode from play mode.

The items indicated by are default settings.

Menu tab	Main menu	Sub menu	Secondary menu	Page
	DEL. ALL	YES	-	p. 49
		NO	-	
	PROTECT	ONE PIC	UNLOCK	p. 49 ~ 50
			LOCK	
		ALL PICS	UNLOCK	
			LOCK	
	SLIDE	OFF ~ 10SEC ▶ ▲ ▼	REPEAT	p. 50 ~ 51
			ON OFF	
	RESIZE	2048 X 1536	-	p. 51
		1600 X 1200	-	
		1024 X 768	-	
		640 X 480	-	
		320 X 240	-	
	COPY TO CARD	NO	-	p. 52
		YES		
	D P O F	STANDARD	▲ 00 ~ 99PRINTS ▼	p. 53
		ONE PIC		
	INDEX	NO	-	p. 54
		YES		
	CANCEL	STANDARD	-	p. 54
		INDEX		

Deleting all images

- Of all the files stored in the memory card, the unprotected files in the DCIM subfolder will be deleted.

● Deleting All images

1. Press and hold the Play mode button for 2 seconds, and press the menu button.
2. Press the LEFT/ RIGHT button and select the [DEL.ALL] menu tab.
3. Select a desired sub menu by pressing the UP/ DOWN button and press the OK button.

Selecting [YES] : A delete confirmation window will appear. Press the OK button to delete all the unprotected pictures. If there aren't protected images, all the images are deleted and a [NO IMAGE!] message will display. Press and hold the Play mode button for 2 seconds or slide the mode switch to remove the message.

Selecting [NO] : The display returns to the initial menu.



INFORMATION

- Remember that this will permanently delete unprotected images. Important shots should be stored on a computer before deletion takes place.

Protecting images

- This is used to protect specific shots from being accidentally erased (LOCK). It also unprotects images that have been previously protected (UNLOCK).

● Protecting Images

1. Press and hold the Play mode button for 2 seconds, and press the Menu button.
2. Press the LEFT/ RIGHT button and select the [PROTECT] menu tab.
3. Select a desired sub menu by pressing the UP/ DOWN button and press the OK button.

[ONE PIC] : Only an image that is displayed on the LCD monitor is protected or unprotected.

[ALL PICS] : All of the stored images are protected or unprotected.



Protecting images

- Select the desired secondary menu by pressing the UP/DOWN button and press the OK button.
[UNLOCK] : Cancels the protect function.
[LOCK] : Sets up the protect function.
 - If you select the [ONE PIC] sub menu at step 3, you can protect or unprotect another image by pressing the LEFT/ RIGHT button. If you press the SHUTTER button, the Image Protection menu will disappear.
 - If you protect an image, the protect icon() will be displayed on the LCD monitor. (An unprotected image has no indicator)
 - An image in LOCK mode will be protected from [DELETE] or [DEL.ALL] functions, but will NOT be protected from the [FORMAT] function.
- Press the shutter button and the menu will disappear.



Starting the slide show

- Images can be displayed continuously at pre-set intervals. You can view the slide show by connecting the camera to an external monitor.

- Press and hold the Play mode button for 2 seconds, and press the Menu button.
- Press the LEFT/ RIGHT button and select the [SLIDE] menu tab.
- Use the UP and DOWN buttons to select the desired submenu value, and then press the RIGHT button.
 - Slide Show Display Interval: OFF, 1 ~10 seconds
- Use the UP and DOWN buttons to set whether to repeat the slide show.



- [ON] : Even once a cycle(from the first image to the last image) is completed, the slide show will continue to repeat itself.
- [OFF]: If a cycle is completed, the slide show will stop automatically.

- Press the OK button and the slide show will start.
 - To pause the slide show, press the shutter button.
 - To start the slide show again, press the shutter button again.
 - Press the menu button again and the slide show will stop.

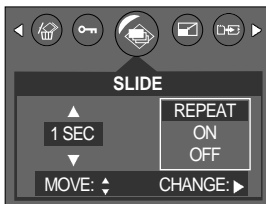

Starting the slide show

INFORMATION

- The loading time depends on the image size and quality.
- The slide show will start from an image that was displayed on the LCD monitor. The [PWR OFF] function can't be activated.
- While the slide show is playing, only the first frame of an avi file is displayed.
- In case of a voice file, the voice recording icon will appear.

Resize

- You can change the resolution (size) of saved pictures. The pictures are saved under different names.

1. Press and hold the Play mode button for 2 seconds, and press the Menu button.
2. Press the LEFT/ RIGHT button and select the [RESIZE] menu tab.
3. Select a desired sub menu by pressing the UP/ DOWN button and press the OK button.



INFORMATION

- A Large image can be resized to be made smaller, but a small image cannot be resized to become larger.
- Only JPEG images can be resized. Avi and wav files can't be resized.
- You can change the resolution of only those files compressed in the JPEG 4:2:2 format.
- The resized image will have a new file name.
- If the memory capacity is insufficient to store the resized image, a [CARD FULL!] message will display on the LCD monitor and the resized image will not be stored.

COPY TO CARD

■ This enables you to copy image files to the memory card.

● Copying to the Memory Card

1. Press and hold the Play mode button for 2 seconds, and press the Menu button.

2. Select the [COPY TO CARD] menu tab by pressing the LEFT/ RIGHT button.

3. Select a desired sub menu by pressing the UP/ DOWN button and press the OK button.

- [NO] : The Play mode screen is displayed

- [YES] : All images saved in the internal memory are copied to the memory card after the [PLEASE WAIT] message is displayed. After copying has been completed, the screen will return to play mode.



INFORMATION

- If the function is used without an inserted memory card, the [NO CARD !] message is displayed, and the Play mode screen is displayed.
- If there is not enough space available in the memory card to copy saved images in the internal memory (32MB), the [COPY TO CARD] command will copy only some of the images and display [CARD FULL!] message. Then the system will return to the playback mode. Please be sure to delete any unnecessary images to free up space before inserting the memory card into the camera.

DPOF

■ DPOF

- DPOF stands for Digital Print Order Format. It allows you to save the picture printing information in the DCIM/MISC folder on the memory card. Select the pictures to be printed and how many prints to make.
- The DPOF indicator will display on the LCD monitor when an image that has DPOF information plays back. Images can then be printed on DPOF printers, or at an increasing number of photo labs.
- This function is not available for Movie clips and Voice recording files.
- The DPOF function is available only for images saved in a memory card.
- To add DPOF information to an image saved in the internal memory, please use the [COPY TO CARD], to copy the image to the memory card first.

DPOF : STANDARD

- This function allows you to embed print quantity information on a stored image.

1. Press and hold the Play mode button for 2 seconds, and press the Menu button.
2. Press the LEFT/ RIGHT button and select the [DPOF] menu tab.
3. Select the [STANDARD] menu by pressing the UP/ DOWN button and press the RIGHT button.
4. Use the UP and DOWN buttons to select [ONE PIC] or [ALL PICS], and then press the OK button. A window for selecting number of copies will be displayed.
[ONE PIC] : Set the number of copies to print for the current picture only.
[ALL PICS] : Set the number of copies to print for each picture, excluding movie clips and voice recordings.
5. Use the UP and DOWN buttons to select the number copies and then press the OK button.

- The DPOF icon () will appear by the pictures for which the number of copies to print is set.

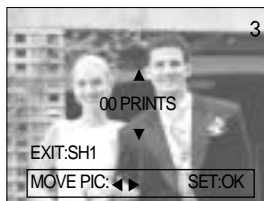

DPOF : INDEX

- Images (except for movie clips and voice file) are printed as index type.

1. Press and hold the Play mode button for 2 seconds, and press the Menu button.
2. Press the LEFT/ RIGHT button and select the [DPOF] menu tab.
3. Select the [INDEX] menu by pressing the UP/ DOWN button and press the RIGHT button.
4. Select a desired sub menu by pressing the UP/ DOWN button.

If [NO] is selected : Cancel the index print setting.

If [YES] is selected : The image will be printed in index format.

5. Press the OK button to confirm the setting.
6. Press the menu button twice and the menu will disappear.



DPOF : CANCEL

- You can cancel the [STANDARD], [INDEX] settings.
Cancel the setting to reset the value to its default.

1. Press and hold the Play mode button for 2 seconds, and press the Menu button.
2. Press the LEFT/ RIGHT button and select the [DPOF] menu tab.
3. Select the [CANCEL] menu by pressing the UP/ DOWN button and press the RIGHT button.
4. Select a desired sub menu by pressing the UP/ DOWN button.

If [STANDARD] is selected : Cancels the standard print setting.

If [INDEX] is selected : Cancels the index print setting.









5. Press the OK button to confirm the setting.
6. Press the menu button twice and the menu will disappear.



Setup menu

■ In this mode, you can set up basic settings. You can use the setup menu in all camera modes, except Voice Recording mode.

The items indicated by  are default settings.

Menu tab	Main menu	Sub menu	Secondary menu	Page
	FILE	 RESET	-	p.56
		SERIES	-	
	PWR OFF	CANCEL, 1~3-10MIN ▲ ▼		p.57
	LANGUAGE	ENGLISH	ESPAÑOL	p.58
		한국어	ITALIANO	
		FRANÇAIS	简体中文	
		DEUTSCH	繁體中文	
	FORMAT	 NO	-	p.58
		YES	-	
	DATE	04/05/01 13:00	-	p.59 ~ 60
		 Y/M/D	-	
		M/D/Y	-	
		D/M/Y	-	
	IMPRINT	 OFF	-	p.59 ~ 60
		DATE	-	
		D&TIME		
	SOUND	OFF		p.60
		LOW		
		 MEDIUM		
		HIGH		
	LCD	DARK		p.60
 NORMAL				
BRIGHT				
RESET	 NO		p.61	
	YES			

Setup menu

Menu tab	Main menu	Sub menu	Secondary menu	Page
	LAMP	ON		p.61
		OFF		
	VIDEO	NTSC		p.62
		PAL		
	Q.VIEW	OFF, 1 ~ 3 SEC		p.63

File name

■ This function allows the user to select the file naming format.

● Assigning File Names

1. In any mode with the exception of Voice Recording mode, press the MENU button.
2. Press the LEFT/ RIGHT button and select the [SETUP] menu tab.
3. Select the [FILE] menu by pressing the UP/ DOWN button and press the RIGHT button.
4. Select a desired sub menu by pressing the UP/ DOWN button and press the OK button.



[RESET] : After using the reset function, the next file name

will be set from 0001 even after formatting, deleting all or inserting a new memory card.

[SERIES] : Under this system, the file name will directly follow the last stored file name, regardless of any actions such as file deletion or formatting.

5. Press the menu button twice and the menu will disappear.

INFORMATION

- The first stored folder name is 100SSCAM, and the first file name is SCD40001.
- File names are assigned sequentially from SCD40001 → SCD40002 → ~ → SCD49999.
- The folder number is assigned sequentially from 100 to 999 as follows: 100SSCAM → 101SSCAM → ~ → 999SSCAM.
- The files used with the memory card conform to the DCF(Design rule for Camera File systems) format.

Auto power off

- This function switches the camera off after a set amount of time in order to prevent unnecessary battery drainage.

● Setting Power Off

1. In any mode with the exception of Voice Recording mode, press the MENU button.
2. Press the LEFT/ RIGHT button and select the [SETUP] menu tab.
3. Select the [PWR OFF] menu by pressing the UP/ DOWN button and press the RIGHT button.
4. A menu will be displayed on the LCD monitor as shown alongside.

Select a desired sub menu by pressing the UP/ DOWN button and press the OK button.

Selecting [CANCEL] :

The power off function will not operate.

Selecting [1 ~ 10 MIN] :

The power will turn off automatically if not used for the period of time specified.

5. Press the menu button twice and the menu will disappear.



INFORMATION

- Even if the batteries or AC adapter are removed and inserted again, the power off setting will be preserved.
- Note that the automatic power off function will not operate if the camera is in PC mode, slide show, playing back a voice recording or movie clip.

Language

- There is a choice of languages that can be displayed on the LCD monitor. Even if the batteries or AC adapter are removed and inserted again, the language setting will be preserved.

● Setting Language

1. In any mode with the exception of Voice Recording mode, press the MENU button.
2. Press the LEFT/ RIGHT button and select the [SETUP] menu tab.
3. Select the [LANGUAGE] menu by pressing the UP/ DOWN button and press the RIGHT button.
4. Select a desired sub menu by pressing the UP/ DOWN button and press the OK button.



LANGUAGE sub menu : Korean, English, French, German, Italian, Spanish, S.Chinese, T.Chinese

5. Press the menu button twice and the menu will disappear.

Formatting a memory card

- This is used for formatting the memory card. If you run [FORMAT] on the memory card, all images, including the protected images, will be deleted. Be sure to download important images to your PC before formatting the memory card.
- If the memory card is not inserted, the internal memory will be formatted.

● Formatting a Memory Card

1. In any mode with the exception of Voice Recording mode, press the MENU button.
2. Press the LEFT/ RIGHT button and select the [SETUP] menu tab.
3. Select the [FORMAT] menu by pressing the UP/ DOWN button and press the RIGHT button.
4. Select a desired sub menu by pressing the UP/ DOWN button and press the OK button.



If [NO] is selected : The memory card will not be formatted.

If [YES] is selected : A [PLEASE WAIT!] message appears and the memory card will be formatted. If you ran FORMAT in Play mode, a [NO IMAGE!] message will appear.

INFORMATION

- Be sure to run [FORMAT] on the following types of memory card.
 - A new memory card, or an unformatted memory card.
 - A memory card that has a file this camera can't recognize or one that has been taken from another camera.
- Always format the memory card using this camera. If you insert a memory card that has been formatted using other cameras, memory card readers, or PCs, you will get a [CARD ERROR!] message.

Setting up the Date/ Time/ Date type

- You can change the date and time that will be displayed on the captured images and set up the date type.

- Setting Date/Time & Selecting Date type

1. In any mode with the exception of Voice Recording mode, press the MENU button.
2. Press the LEFT/ RIGHT button and select the [SETUP] menu tab.
3. Select the [DATE] menu by pressing the UP/ DOWN button and press the RIGHT button.
4. Use the UP, DOWN, LEFT, and RIGHT buttons to select the desired submenu value, and then press the OK button.

RIGHT button : Selects the year/month/day/hour/minute/date type.

LEFT button : Moves the cursor to the [DATE] main menu if the cursor is at the first item of the date and time setup. In all other cases, the cursor will be shifted to the left of its current position.

UP and DOWN buttons: Changes the setting value.

- Date type

[Y/M/D] : year/month/day

[M/D/Y] : month/day/year

[D/M/Y] : day/month/year

5. Press the menu button twice and the menu will disappear.



Imprinting the recording date

- There is an option to include DATE/TIME on still images.

- Date Imprinting

1. In any mode with the exception of Voice Recording mode, press the MENU button.
2. Press the LEFT/ RIGHT button and select the [SETUP] menu tab.
3. Select the [IMPRINT] menu by pressing the UP/ DOWN button and press the RIGHT button.
4. Use the UP and DOWN buttons to select the desired date imprint type, and then press the OK button.

[OFF] : The DATE & TIME will not be imprinted on the image file.

[DATE] : Only the DATE will be imprinted on the image file.

[D&TIME] : The DATE & TIME will be imprinted on the image file.

5. Press the menu button twice and the menu will disappear.

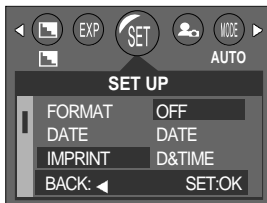

Imprinting the recording date

INFORMATION

- The Date & Time are imprinted at the bottom right side of the still image.
- The date will be imprinted as a DATE TYPE setting.
- TIME is imprinted in the following way : [Hour : Minute] and hours are shown using the 24 hour clock.
- The imprint function is applied only to still images.

Sound

- If a sound option other than [OFF] is selected, the camera activity can be monitored with sounds including a start up sound and a shutter sound.

● Setting Operation Sounds

1. In any mode with the exception of Voice Recording mode, press the MENU button.
2. Press the LEFT/ RIGHT button and select the [SETUP] menu tab.
3. Select the [SOUND] menu by pressing the UP/ DOWN button and press the RIGHT button.
4. Select a desired sub menu by pressing the UP/ DOWN button and press the OK button.
 - [SOUND] sub menu : OFF/LOW/MEDIUM/HIGH
5. Press the menu button twice and the menu will disappear.

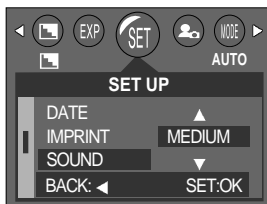

LCD brightness

- You can adjust the LCD brightness.
- ### ● Adjusting LCD brightness
1. In any mode with the exception of Voice Recording mode, press the MENU button.
 2. Press the LEFT/ RIGHT button and select the [SETUP] menu tab.
 3. Select the [LCD] menu by pressing the UP/ DOWN button and press the RIGHT button.
 4. Select a desired sub menu by pressing the UP/ DOWN button and press the OK button.
 - [LCD] sub menu : DARK/NORMAL/BRIGHT
 5. Press the menu button twice and the menu will disappear.



Initialization(RESET ALL)

- All camera menu and function settings will be restored to their default values. However, values for DATE/TIME, LANGUAGE, and VIDEO OUT will not be changed.

● Initializing the Camera

1. In any mode with the exception of Voice Recording mode, press the MENU button.
2. Press the LEFT/ RIGHT button and select the [SETUP] menu tab.
3. Select the [RESET] menu by pressing the UP/ DOWN button and press the RIGHT button.
4. Select a desired sub menu by pressing the UP/ DOWN button and press the OK button.



If [NO] is selected : Settings will not be restored to their defaults.

If [YES] is selected : All settings will be restored to their defaults.

5. Press the menu button twice and the menu will disappear.

Function lamp

- You can turn on and off the function lamp located on the front of the camera.

● Setting the function lamp

1. In any mode with the exception of Voice Recording mode, press the MENU button.
2. Press the LEFT/ RIGHT button and select the [SETUP] menu tab.
3. Select the [LAMP] menu by pressing the UP/ DOWN button and press the RIGHT button.
4. Select a desired sub menu by pressing the UP/ DOWN button and press the OK button.



If [OFF] is selected : The function lamp will not light up.

If [ON] is selected : The function lamp will light up.

5. Press the menu button twice and the menu will disappear.

● Description of the Function lamp

Function	Description
During power-on	The function lamp is on during initialization. When the camera is ready for operation, the lamp is turned off.
After an image is captured	The function lamp blinks once.
During voice recording	The function lamp (Blue) blinks repeatedly.
When the self-timer activated	The function lamp (Blue) blinks.

Selecting Video out type

- The Movie output signal from the camera can be NTSC or PAL.

Your choice of output will be governed by the type of device (monitor or TV, etc.) to which the camera is connected. PAL mode can support only BDGHI.

● Setting the Video Out Type

1. In any mode with the exception of Voice Recording mode, press the MENU button.
2. Press the LEFT/ RIGHT button and select the [SETUP] menu tab.
3. Select the [VIDEO] menu by pressing the UP/ DOWN button and press the RIGHT button.
4. Select a desired sub menu by pressing the UP/ DOWN button and press the OK button.
 - [VIDEO] sub menu : NTSC, PAL
5. Press the menu button twice and the menu will disappear.



● Connecting to an external monitor

In RECORDING/ PLAY mode, you can view the stored still images or movie clips by connecting the camera to an external monitor via the A/V cable. When the camera is connected to an external monitor, the LCD monitor will be turned off automatically.

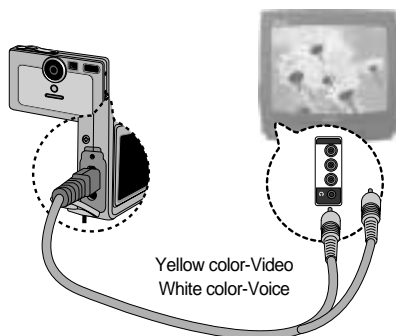

INFORMATION

- NTSC : U.S.A, Canada, Japan, South Korea, Taiwan, Mexico.
- PAL : Australia, Austria, Belgium, China, Denmark, Finland, Germany, U.K., Holland, Italy, Kuwait, Malaysia, New Zealand, Singapore, Spain, Sweden, Switzerland, Thailand, Norway.
- When using a TV as an external monitor, you will need to select the external or AV channel of the TV.
- There will be a digital noise on the external monitor, but it is not a malfunction.
- If the image is not in the centre of the screen, use the TV controls to centre it.
- When the camera is connected to an external monitor, the menu will be visible on the external monitor and the menu functions are the same as those indicated on the LCD monitor.

Quick view

- If you enable Quick View before capturing an image, you can view the image you just captured on the LCD monitor for the duration set in the [Q.VIEW] setup. Quick view is possible only with still images.

● Setting Quick View





1. In any mode with the exception of Voice Recording mode, press the MENU button.
2. Press the LEFT/ RIGHT button and select the [SETUP] menu tab.
3. Select the [Q.VIEW] menu by pressing the UP/ DOWN button and press the RIGHT button.
4. Select a desired sub menu by pressing the UP/ DOWN button and press the OK button.



-
-
-
5. Select a desired sub menu by pressing the UP/ DOWN button and press the OK button.
 - [OFF] : The quick view function can't be activated.
 - [1 ~ 3 SEC] : The captured image is briefly displayed during the selected time.
5. Press the menu button twice and the menu will disappear.

Setting up the MYCAM menu

- You can set up a start up image, start up sound and shutter sound. Every camera working mode (with the exception of Voice recording mode) has the MYCAM menu. The items indicated by  are default settings.

Menu tab	Main menu	Sub menu		Page
	S.IMAGE	OFF	 IMAGE 1	p.64
		IMAGE 2		
	S.SOUND	OFF	 SOUND 1	p.65
		SOUND 2	SOUND 3	
	SH.SOUND	OFF	 SOUND 1	p.65
		SOUND 2	SOUND 3	

Start up image

- You can select the image that is first displayed on the LCD monitor whenever the camera is turned on.
- Setting a Startup Image
 1. In any mode with the exception of Voice Recording mode, press the MENU button.
 2. Press the LEFT/ RIGHT button and select the [MYCAM] menu tab.
 3. Select the [S.IMAGE] menu by pressing the UP/ DOWN button and press the RIGHT button.
 4. Select a desired sub menu by pressing the UP/ DOWN button and press the OK button.
 5. Press the menu button twice and the menu will disappear.



Start up sound

■ You can select the sound that is activated whenever the camera is turned on.

● Setting the Startup Sound

1. In any mode with the exception of Voice Recording mode, press the MENU button.
2. Press the LEFT/ RIGHT button and select the [MYCAM] menu tab.
3. Select the [S.SOUND] menu by pressing the UP/ DOWN button and press the RIGHT button.
4. Select a desired sub menu by pressing the UP/ DOWN button and press the OK button.
5. Press the menu button twice and the menu will disappear.



Shutter sound

■ You can select the shutter sound.

● Selecting the Shutter Sound

1. In any mode with the exception of Voice Recording mode, press the MENU button.
2. Press the LEFT/ RIGHT button and select the [MYCAM] menu tab.
3. Select the [SH.SOUND] menu by pressing the UP/ DOWN button and press the RIGHT button.
4. Select a desired sub menu by pressing the UP/ DOWN button and press the OK button.
5. Press the menu button twice and the menu will disappear.



Important notes

Be sure to observe the following precautions!

- This unit contains precision electronic components.
 - Do not use or store this unit in the following locations.
 - Areas exposed to severe changes in temperature and humidity.
 - Areas exposed to dust and dirt.
 - Areas exposed to direct sunlight or the inside of a vehicle in hot weather.
 - Environments where there is high magnetism or excessive vibration.
 - Areas with high explosives or highly flammable materials.

- Do not let the unit come into contact with dust, vinyl goods, or chemicals, such as insecticides, for an extended period of time.

- Sand can be particularly troublesome to cameras.
 - Do not let sand get inside the unit when using it on beaches, coastal dunes, or other areas where there is lots of sand.
 - Doing so may result in failure or may permanently render the unit unusable.

- Extremes in temperature may cause problems.
 - If the camera is transferred from a cold to a warm and humid environment, condensation can form on the delicate electronic circuitry. If this occurs, turn the camera off and wait for at least 1 hour until all moisture is dispersed. Moisture build up can also occur in the memory card. If this happens, turn off the camera and remove the memory card. Wait until the moisture has dispersed.

- Caution on Using the Lens
 - If the lens is subjected to direct sunlight, it could result in discoloration and deterioration of the image sensor.
 - Pay attention not to get fingerprints or foreign substances on the surface of the lens.

- If the digital camera is not used for a long period, an electric discharge can occur. It is a good idea to remove the batteries and the memory card if you do not intend using the camera for an extended period of time.

Important notes

- If the camera is exposed to an electronic interference, it will turn itself off to protect the memory card.

- Camera Maintenance
 - Use a soft brush (available from photo stores) to gently clean the lens and LCD assemblies. If this does not work, lens-cleaning paper with lens cleaning fluid can be used.
 - Clean the camera body with a soft cloth. Do not allow this camera to come into contact with solvent materials such as benzol, insecticide, thinners etc. This may damage the body shell of the camera and also affect its performance. Rough handling can damage the LCD monitor. Take care to avoid damage and keep the camera in its protective carry case at all times when not in use.

- Do not attempt to disassemble or modify the camera.

- Under certain conditions, static electricity can cause the flash unit to fire. This is not harmful to the camera and is not a malfunction.

- When images are uploaded or downloaded, the data transfer may be affected by static electricity. In this case, disconnect and re-connect the USB cable before trying the transfer again.

Warning indicator

- There are several warnings that may appear on the LCD display

Warning indicator	Causes	Remedy
CARD FULL !	<ul style="list-style-type: none">• There is insufficient memory capacity to take an image.	<ul style="list-style-type: none">• Insert a new CARD or delete stored images to free up some memory.
LOW LIGHT !	<ul style="list-style-type: none">• When taking pictures in dark places.	<ul style="list-style-type: none">• Use a tripod and take pictures in Flash Photography mode.
CARD LOCKED !	<ul style="list-style-type: none">• The memory card is locked.	<ul style="list-style-type: none">• Slide the write protect switch to the bottom of the memory card.
NO IMAGE !	<ul style="list-style-type: none">• There are no images stored on the internal memory or the CARD.	<ul style="list-style-type: none">• Take images.• Insert a memory card that is holding some images
CARD ERROR!	<ul style="list-style-type: none">• Memory card error	<ul style="list-style-type: none">• Insert a new card or format the memory.
MEMORY ERROR!	<ul style="list-style-type: none">• Internal memory error	<ul style="list-style-type: none">• Format the memory with the memory card removed.
A battery indicator blinks!	<ul style="list-style-type: none">• There is low battery capacity	<ul style="list-style-type: none">• Insert fresh batteries
Camera shake warning indicator!	<ul style="list-style-type: none">• The flash mode is set to flash off	<ul style="list-style-type: none">• Disengage the FLASH OFF mode (For ordinary shots)• Use a tripod (For taking shots in more unusual circumstances ; museum, art center)

Before contacting a service center

Please check the following

Symptom	Causes	Remedy
The camera doesn't switch on	<ul style="list-style-type: none"> - There is low battery capacity - An AC Power Adapter is not connected 	<ul style="list-style-type: none"> - Insert fresh batteries - Connect an AC Power Adapter
The camera power ceases whilst in use	<ul style="list-style-type: none"> - The batteries are exhausted - The Camera is turned off automatically. - The Adapter plug is not connected securely 	<ul style="list-style-type: none"> - Insert fresh batteries - Push the power button to reactivate camera - Remove and re-insert the plug
Batteries drain quickly	<ul style="list-style-type: none"> - The Camera is being used in low temperatures 	<ul style="list-style-type: none"> - Keep the camera in warm conditions (i.e. inside a coat or jacket) and only remove it in order to take images
Camera does not take images when pressing the Shutter button	<ul style="list-style-type: none"> - There is insufficient memory capacity - The memory card has not been formatted - The memory card is exhausted - The camera's power is off - The batteries are exhausted - The memory card is locked 	<ul style="list-style-type: none"> - After turning the camera off, insert a new memory card or delete unnecessary image files. - Format the memory card. - Insert a new memory card - Turn the camera power on - Insert fresh batteries - Slide the write protect switch to the bottom of the memory card
The images are unclear	<ul style="list-style-type: none"> - A picture was taken within 0.6m from the subject without setting an appropriate macro mode - Taking a picture beyond the flash range - The lens is smudged or dirty 	<ul style="list-style-type: none"> - If the subject is closer than 0.6m, select macro shot mode or increase the camera to subject distance - Take a picture within the flash range - Clean the lens
The flash does not fire	<ul style="list-style-type: none"> - FLASH OFF mode has been selected. 	<ul style="list-style-type: none"> - Disengage FLASH OFF mode
Incorrect date and time is displayed	<ul style="list-style-type: none"> - The date and time have been set incorrectly. 	<ul style="list-style-type: none"> - Reset the date and time correctly. (p.59 ~ 60)

Before contacting a service center

Symptom	Causes	Remedy
The camera buttons do not operate	<ul style="list-style-type: none"> • Camera malfunction 	<ul style="list-style-type: none"> • Remove / re-insert batteries and switch camera on
A card error has occurred while the memory card is in the camera.	<ul style="list-style-type: none"> • Incorrect memory card format 	<ul style="list-style-type: none"> • Re-format the memory card (p.58)
Colour of image is different to the original scene	<ul style="list-style-type: none"> • White balance setting is incorrect. 	<ul style="list-style-type: none"> • Select appropriate White balance.
Images are too bright	<ul style="list-style-type: none"> • Exposure is excessive. 	<ul style="list-style-type: none"> • Reset exposure compensation.
The play back display is not very clear	<ul style="list-style-type: none"> • The lens or LCD monitor is smudged or dirty 	<ul style="list-style-type: none"> • Clean the lens or LCD
Date is not displayed on the LCD monitor in the PLAY mode	<ul style="list-style-type: none"> • Date imprint function is set to OFF 	<ul style="list-style-type: none"> • Switch the Date imprint function ON.
When using the PC's explorer, the [Removable Disk] file does not show	<ul style="list-style-type: none"> • Cable connection is incorrect. • The camera is off. • There are no batteries, the batteries are exhausted or the AC adapter is not connected. • The operating system is not Windows 98, 98SE, 2000, ME, XP/ Mac OS 9.0~10.2. Alternatively the PC does not support USB. • The USB driver is not installed. 	<ul style="list-style-type: none"> • Check the connection. • Turn the camera on. • Insert new batteries or check the adapter connection. • Install Windows 98, 98SE, 2000, ME, XP/ Mac OS 9.0~10.2 to PC that supports USB. • Install a [USB Storage Driver].
The images don't play back.	<ul style="list-style-type: none"> • Incorrect file name. (Violation of DCF format) 	<ul style="list-style-type: none"> • Do not change the image file name.

Specification

Image Sensor	Type	1/2.5" CCD
	Effective Pixels	Approx. 4.0 Mega-pixel
	Total Pixels	Approx. 4.2 Mega-pixel
Lens	Focal lens	SHD Lens f=5.8mm (35mm film equivalent : 35mm)
	F No.	F.3.2
	Digital Zoom	Still Image mode: 1.0X~ 4.0X, Play mode: 1.0X~8.0X
Viewfinder	Optical Viewfinder	Optical virtual image viewfinder
	LCD Monitor	1.5" color TFT LCD
Focusing	Type	TTL Auto Focus
	Range	Normal: 60cm ~ infinity, Macro: 6cm ~ 60cm
Shutter	Type	Mechanical and Electronic shutter
	Speed	Normal Mode: 4- 1/2,000 sec.(Night Scene: 8-1/2,000 sec.)
Exposure	Control	Program AE Metering (Multi. & Spot)
	Compensation	±2.0EV (0.5EV steps)
	ISO Equivalent	Auto, 100, 200, 400
Flash	Modes	Auto, Auto & Red - eye reduction, Slow sync, Fill-in flash, Flash off
	Range	0.2 ~ 2m
	Recharging Time	Approx. 5 sec.
Sharpness		Soft, Normal, Vivid
Effect		Normal, B&W, Sepia
Voice Recording		Voice Recording (max 1 hour) Voice Memo on Still Image (max 10 sec.)
Date Imprinting		Date, Date & Time, Off (user selectable)
White Balance		Auto / Daylight / Cloudy/ Sunset / Fluorescent / Tungsten
Shooting	Still Image	Modes: Auto, Night, Myset, Text mode Shooting: Single, Continuous, AEB
	Movie Clip	With audio (Recording time: memory capacity dependent) Size: 320x240, 640x480
Self-timer (Single, Double)		10 sec, 2sec, Double self

Specification

Storage	Media	Internal memory: 32MB flash memory External memory (optional):MS Duo (Upto128MB guaranteed)
	File Format	Still Image: JPEG (DCF), DPOF, EXIF Movie Clip: AVI (MJPEG) Audio : WAV
	Image Size	2272: 2272X1704, 2048: 2048X1536, 1600: 1600X1200, 1024: 1024X768, 640: 640X480
	Capacity (32MB Internal Memory)	2272 : Super fine 14, Fine 28, Normal 43 2048 : Super fine 16, Fine 35, Normal 53 1600 : Super fine 29, Fine 58, Normal 80 1024 : Super fine 67, Fine 142, Normal 165 640 : Super fine 159, Fine 306, Normal 360 * These figures are measured under Samsung's standard conditions and may vary depending on shooting conditions and camera settings.
Image Play		Single image / Thumbnails / Slide show/ Movie Clip
Image Edit		Trimming, Resizing
Interface		Digital output connector : USB, Audio : Mono Video output : NTSC, PAL(user selectable) DC power input connector : 5.0V
Power Source		Primary battery : CP1 Rechargeable battery : Self Charging System, SLB-1037(1,000mAh, 3.7V) AC Adapter : SAC-51(5.0V,2.0A) ※ Included battery source may vary depending on sales region.
Dimensions (WxHxD)		97 x 60 x 15.4mm
Weight		Approx. 90g(without batteries and card)
Software	Camera Driver	Storage Driver (Windows98/98SE/2000/ME/XP, Mac OS 9.0~10.2)
	Application	Digimax Viewer 2.1, Arcsoft PhotoImpression 4.0, Digimax Reader

※Specifications are subject to change without prior notice.

Software Notes

Please ensure that you read the instruction manual carefully before use.

- . The attached software is a camera driver and image editing software tool for Windows.
- . Under no circumstances should all or part of either the software or the user manual be reproduced.
- . Copyrights for software are licensed only for use with a camera.
- . In the unlikely event of a manufacturing fault, we will repair or exchange your camera. We cannot, however, be held responsible in any way for damage caused by inappropriate use.
- . Using a Hand-made PC or a PC and OS that has not been guaranteed by the manufacturer is not covered by the Samsung warranty.
- . Before reading this manual, you should have a basic knowledge of computers and O/S (Operating Systems).

System Requirements

For Windows	For Macintosh
PC with processor better than MMX Pentium 233MHz (XP : Pentium II 300MHz)	Power Mac G3 or later
Windows 98/98SE/2000/ME/XP	Mac OS 9.0 ~ 10.2
Minimum 32MB RAM (XP : 128MB) 140MB of available hard-disk space	Minimum 64MB RAM 110MB of available hard-disk space
USB port	USB port
CD-ROM drive	CD-ROM drive
800x600 pixels, 16-bit colour display compatible monitor (24-bit color display recommended)	QuickTime 4.0 or later for Movie Clip

About the software

After inserting the CD-ROM provided with this camera into the CD-ROM drive, the following window should automatically run.



Before connecting the camera to the PC, you should first install the camera driver.

- **Camera driver** : This enables images to transfer between the camera and PC.
This camera uses the USB Storage Driver as the camera driver. You can use the camera as a USB card reader. After installing the driver and connecting this camera to the PC, you can find [Removable Disk] in [Windows Explorer] or [My computer]. A USB Storage Driver is provided only for Windows. A USB Driver for MAC is not included with the Application CD. But you can use the camera with Mac OS 9.0 ~ 10.2.
- **Digimax Viewer** : This is a program for viewing stored images.
You can see the stored images in the memory directly on a PC monitor. You can also copy, move or delete the images and enlarge/downscale the image sizes with Digimax Viewer. This software is only compatible with Windows.
- **PhotoImpression** : Image editing program.
You can edit or store still images that you download from the camera. This software is only compatible with Windows.

INFORMATION

- Be sure to check the system requirements (page 73) before installing the driver.
- You should allow 5~10 seconds for running the automatic setup program according to the capability of the computer. If the frame does not show, run the [Windows Explorer] and select [Samsung.exe] in the CD-ROM Drive root directory.

Setting up the application software

To use this camera with a PC, install the application software first. After this has been done, the stored images in the camera can be moved to the PC and can be edited by an image editing program.

INFORMATION

- Close other programs before installing the application software.
- Before installing the application software, disconnect the USB connection.

You can visit the Samsung web-site through the internet.

<http://www.samsungcamera.com> : English

<http://www.samsungcamera.co.kr> : Korean

1. Click the [Install] menu in the Autorun frame.
The Digimax U-CA 401 camera driver is installed automatically.

[Click!]



2. Camera driver installation is complete.
Click the [Finish] button.

[Click!]



Setting up the application software

3. A window for which you can select application software will be displayed. Select the application program and click the [Install] button.

Refer to page.74 for more information about the application program.

[Click!]



INFORMATION

- If you select [Exit] at the step 3, the application program installation will be cancelled.

4. Install Digimax Viewer.

Click [Next >] button.

[Click!]



INFORMATION

- If you select [Cancel] at step 4, a window for installing PhotoImpression will be displayed.

5. The Software License Agreement window will be displayed. If you agree to this, click [Yes], the window will then move to the next step.

If you disagree, click [No] and the installation program will be canceled.

[Click!]

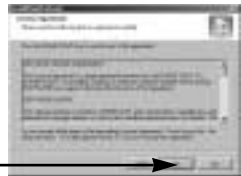

6. A destination selection window will open. Click [Next >]. To copy to the files to another folder, click [Browse ..] and choose a folder you want.

[Click!]



Setting up the application software

7. A window will open, asking you to choose a folder to which program icons will be added. Click [Next >] button.

If you want to add the program icons to a different folder, choose another folder, and then click [Next >] button.

[Click!]

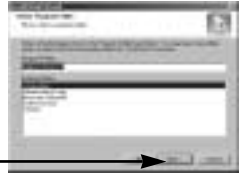

8. Digimax Viewer installation is successfully completed. Click the [Finish] button to install Photolmpression. The system will not reboot even the [Yes, I want to restart the computer now] option is selected.

*The frame 8 may not appear according to the system requirements. Click the [Finish] button.

[Click!]

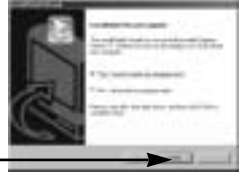

9. Digimax Viewer Installation is completed. The Photolmpression installation window will be displayed as shown alongside. Click the [OK] button.

[Click!]

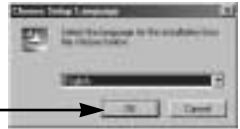

INFORMATION

- If you click [Cancel] in Step 9, the Photolmpression installation will be canceled and the Restart Computer window will appear.

10. A Welcome window will be displayed. Click the [Next >] button.

[Click!]



Setting up the application software

11. The Software License Agreement window will be displayed. If you agree to this, click [Yes], the window will then move to the next step. If you disagree, click [No] and the installation program will be canceled.



12. A destination selection window will open. Click [Next >]. To copy to the files to another folder, click [Browse...] and choose a folder you want.



13. The [Select Components] window will appear. Click [Next >] button.



14. A window will open, asking you to choose a folder to which program icons will be added. Click [Next >] button. If you want to add the program icons to a different folder, choose another folder, and then click [Next >] button.



15. Installation is complete. Click the [Finish] button.
* The frame 15 may not appear according to the system requirements.



Setting up the application software

16. To apply changes, you must restart the computer. Select [Yes, I want to restart my computer now], and then click [OK].

[Click!]



17. After restarting the computer, connect the PC to the camera with the USB cable.

18. Turn the camera power on. [Found New Hardware Wizard] will open and the computer will recognize the camera.

- ※ If you have ever installed an image viewer program or your OS is Windows XP, an image viewer program will open.
If the image viewer program opens, the camera driver was setup successfully.



19. If you can see [Removable Disk] under [My computer], the camera driver installation was successful.
Now you can transfer image files from the camera to PC via the USB cable.



Setting up the application software

INFORMATION

- If you have installed the camera driver, [Found New Hardware Wizard] may not open.
- On a Windows 98 or 98 SE system, the Found New Hardware Wizard dialog box opens and a window asking you to select a driver file may appear. In this case, specify the [USB Driver] folder on the supplied software CD.
- When connecting the camera to your PC, it is recommended that you use an AC power adapter.
- Before connecting the camera to the PC, You should first install the camera driver.
- After installing the camera driver, you have to restart your PC.
- If you connect the camera to the PC before installing the camera driver, the [Found New Hardware Wizard] will open.
In this case, cancel the [Found New Hardware Wizard] and disconnect the camera. Install the camera driver and connect the camera to the PC again.
- Should the computer not find the camera driver after installation, please try one or more of the following measures.
 1. Delete the camera driver (p.84), and re-install the driver.
 2. Refer to FAQ (p.90) to check for a possible solution to the problem.
 3. If your PC's central processing unit is VIA chip (This is shown in the USB Host Controller), download the patch file from the Samsung Camera web page.
(<http://www.samsungcamera.com>)

Starting PC Mode

- If you insert the USB cable into the USB connection terminal, the camera mode will change to the PC mode automatically.
- In this mode, you can download stored images to your PC through the USB cable.
- The LCD monitor is always turned off in PC mode.
- The auto focus lamp will blink when the files are transferring via the USB connection.

■ Connecting the camera to PC

1. Turn the PC power on.
2. Turn the camera power on.
3. Connect the PC and the camera via the USB cable.
 - Connect the small end of the USB cable to the USB port on the camera.
 - Connect the large end of the USB cable to the USB port on the computer.
 - Make sure the connectors are fully inserted.

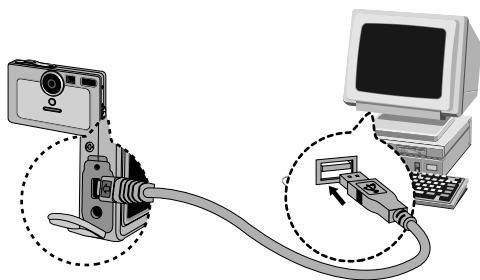

■ Disconnecting the camera and PC

Refer to the following page.

- WIN 98SE : p.86
- WIN 2000/ ME/ XP : p.86 ~ 87

INFORMATION

- The camera driver must be installed before using PC mode. For driver installation instructions, please refer to p.75.
- To save battery power, it is recommended that you use an AC adapter (Optional) when connecting the camera to a computer.

Starting PC Mode

■ Downloading stored images

You can download the still images stored on the camera to your PC's hard disk and print them or use a photo editing software to edit them.

1. Connect the camera to your PC with the USB cable.

2. On your computer's desktop display, select [My computer] and double click [Removable Disk] → DCIM → 100SSCAM].

The image files will then be displayed.



3. Select an image and press the right mouse button.



4. A pop-up menu will open.

Click [Cut] or [Copy] menu.

- [Cut] : cuts a selected file.

- [Copy] : copies files.



5. Click a folder where you want to paste the file.

Starting PC Mode

6. Press the right mouse button and a pop-up menu will open. Click [Paste].



7. An image file is transferred from the camera to your PC.



- By using [Digimax Viewer], you can see the stored images in the memory directly on the PC monitor and you can copy or move the image files.

Removing the USB Driver for Windows 98SE

■ To remove the USB driver, refer to the process shown below.

1. Trace [Start → Settings] and click [Control Panel].



2. Double-click [Add/Remove programs].

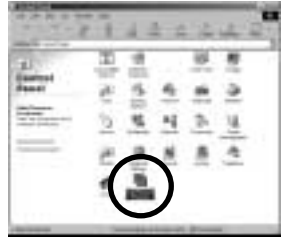

3. The [Add/Remove Programs Properties] window will open. Click [Digimax U-CA 401] and click the [Add/Remove] button.

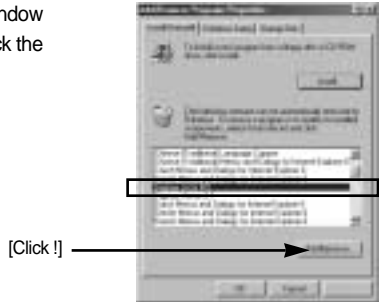

4. Uninstallation is complete.
Click the [Finish] button and the window will disappear.



Removable Disk

■ To use this camera as a Removable Disk, install (p.75) the USB Driver.

1. Before turning the camera power on, connect the camera to the PC with the USB cable.
2. Click [Removable Disk] under [My computer] or [Windows Explorer].
3. Image files stored in the Removable Disk (DCIM →100SSCAM) can be transferred to the PC.

INFORMATION

Important information whilst using the Removable Disk

- The [Removable Disk] indicator will not show when the camera power is off or the USB cable is removed.
- We recommend that you should copy the images to the PC to view them. Opening images directly from the removable disk may be subject to unexpected disconnection.
- When uploading images from the PC to the camera, ensure that the uploaded file names are not the same as those already stored on the memory.
- When you upload a file that is not taken by this camera to Removable Disk, the [FILE ERROR!] message will be displayed on the LCD monitor in the PLAY mode, and nothing is displayed in THUMBNAIL mode.
- The auto focus lamp will blink, when a file is transferred (copy or deletion) between the PC and the camera. Do not remove the USB cable until the lamp stops blinking. To remove the USB cable in Windows 2000/ME/XP, use the [Unplug or Eject Hardware] icon on the task bar.

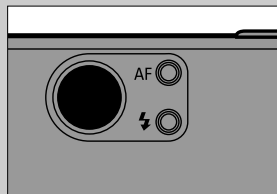

Removing the removable disk

■ Windows 98SE

1. Check whether the camera and PC are transferring a file. If the auto focus lamp blinks, you have to wait until the lamp illuminates.
2. Unplug the USB cable.

■ Windows 2000/ME/XP

(The illustrations may be different from the real display in accordance with the Windows O/S.)

1. Check whether the camera and PC are transferring a file. If the auto focus lamp blinks, you have to wait until the lamp illuminates.

2. Double-click the [Unplug or Eject Hardware] icon on the task bar.



3. The [Unplug or Eject Hardware] window will open. Select the [USB Mass Storage Device] and click the [Stop] button.



4. The [Stop a Hardware device] window will open. Select the [SAMSUNG Digimax U-CA 401 USB Device] and click the [OK] button.

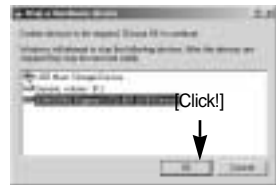

5. A [Safe to Remove Hardware] window will open. Click the [OK] button.



Removing the removable disk

6. A [Unplug or Eject Hardware] window will open.
Click the [Close] button and the removable disk will be removed safely.



7. Unplug the USB cable.

[Click!]

Setting up the USB Driver for MAC

1. A USB Driver for MAC is not included with the software CD as MAC OS supports the camera driver.
2. Check the MAC OS. You can check the MAC OS version during MAC OS start-up.
This camera is compatible with MAC OS 9.0 ~ 10.2.
3. Connect the camera to the Macintosh and turn the camera power on.
4. A new icon will be displayed on the desktop after connecting the camera to the MAC.

Using the USB Driver for MAC

1. Double click a new icon on the desktop and the folder in the memory will be displayed.
2. Select an image file and copy or move it to MAC.

INFORMATION

- For Mac OS 10.0 or later: First complete uploading from computer to camera and then remove the removable disk with the Extract command

Digimax Viewer 2.1

This software is only compatible with Windows.

1. To open Digimax Viewer, click the [Start → Programs → Samsung → Digimax Viewer 2.1 → Digimax Viewer 2.1] and Digimax Viewer 2.1 will then open.



2. If the [Auto Launch] option is selected, this program will be executed automatically with recognizing the camera.



3. You can easily use the Digimax viewer 2.1 program as it offers a FILE menu and TOOL bar. And, you can use the pop up menu. Click an image and press the right mouse button.



Digimax Viewer functions are listed below.

- Basic functions : Copy, Cut, Paste, Delete, Rotate, Rename, changing file type, Resize, Property.
- Advanced functions : Print, Slide show, Export, Sending e-mail, On-line print, Web album etc.

INFORMATION

- Before deleting images from the camera, you should protect or download images to your computer that you wish to keep.
- Refer to the [Help] menu in Digimax viewer 2.1 for further information.

Using Photolmpression





With Photolmpression, you can edit or store still images that you downloaded from the camera. This software is only available in Windows version.

To start the program, click [Start → Programs → ArcSoft Photolmpression → Photolmpression]. The following screen will appear.













You can use Photolmpression to perform the following tasks.

■ Command Button

Button	Description
	Imports a picture from an album, a source folder, or the camera/scanner, or captures screen shots of what is being viewed on the current monitor.
	Selects Cut, Resize, Edit Image, Insert Text, Enhance Picture, Insert Effects, or Layer.
	Performs Insert Frame, Insert Borders, Insert Calendar, Insert Greeting Cards, Insert Template, or Connect with Other Software.
	Saves the edited picture, and sends an e-mail or uses it as the background image.
	Outputs the edited picture according to your preferences.

Using Photolmpression

■ Tool Bar

Button	Description	Button	Description
	Resize Layer		Rotate Layer
	Flip Layer Horizontally		Rotate All Layers
	Undo		Redo
	Copy		Paste
	Delete Layer		Close Picture

INFORMATION

- For detailed instruction on how to use Photolmpression, please refer to the program's Help.

FAQ

- Please check the following if the USB connection malfunctions.

[Case 1]

The camera power is off.

- Turn the camera power on. We recommend using an AC power adapter in PC mode.

[Case 2]

USB Driver is not installed correctly.

- Install the USB Driver correctly. Refer to page 75.

[Case 3]

The USB cable is not connected or you are using a cable with an incorrect specification.

- Use a USB cable with the correct specification.

FAQ

[Case 4]

The camera is not recognized by your PC.
Sometimes, the camera may appear under [Unknown Devices] in Device Manager.

- Install the camera driver correctly.
Turn off the camera, remove the USB cable, plug in the USB cable again, and then turn on the camera.

[Case 5]

There is an unexpected error during file transfer

- Turn the camera power off and on again. Transfer the file again.

[Case 6]

How do I know my computer supports a USB Interface?

- Check the USB port in your computer or keyboard.
- Check the OS version.

A USB Interface is available in Windows 98, 98SE, 2000, ME, XP.

- Check [Universal Serial Bus controllers] in Device Manager.

Do the following to check [Universal Serial Bus controllers].

Win 98/ME : Trace [Start → Settings → Control Panel → System → Device Manager → Universal Serial Bus controllers]

Win 2000 : Trace [Start → Settings → Control Panel → System → Hardware → Device Manager → Universal Serial Bus controllers].

Win XP : Trace [Start → Control Panel → Performance and Maintenance → System → Hardware → Device Manager → Universal Serial Bus controllers].

There must be USB Host Controller and USB root hub under [Universal Serial Bus controllers].

In addition, double-click on the USB Universal Host Controller and the USB Root Hub to check if the Device Status states "This device is working properly". If the Device Status says the device is "not working properly", click the "Driver" tab and then click [Update Driver] or [Reinstall Driver].

- When all the conditions mentioned above are met, the computer can support the USB interface.

[Case 7]

When using the USB hub.

- There may be a problem in connecting the camera to the PC through the USB hub if the PC and the hub are not compatible.
Wherever possible, connect the camera to the PC directly.

[Case 8]

Are other USB cables connected to the PC?

- The camera may malfunction when it is connected to the PC at the same time as another USB cable. In this case, disconnect the other USB cable, and connect only one USB cable to the camera.

FAQ

[Case 9]

When I open the Device Manager (by clicking Start → (Settings) → Control Panel → (Performance and Maintenance) → System → (Hardware) → Device Manager), there are 「Unknown Devices」 or 「Other Devices」 entries with a yellow question mark(?) beside them or devices with an exclamation mark(!) beside them.

- Right-click on the entry with the question(?) or exclamation (!) mark and select "Remove". Restart the PC and connect the camera again.
For Windows 98 PC, remove the camera driver also, restart the PC, and then reinstall the camera driver.
- Double-click on the entry with the question(?) or exclamation(!) mark, click the "Driver" tab, and click [Update Driver] or [Reinstall Driver]. If a message appears asking you to specify the location where the appropriate driver for the device is, specify the "USB Driver" folder (where D: is the drive letter of the CD-ROM where the driver CD is inserted).

■ Please check the following if the movie clip doesn't play back.

※ If you installed an incorrect codec onto your PC, the movie clip may not play back on the PC.

1. Check whether the JPEG Decoder provided with the camera is installed.

→ If you didn't install the camera driver, please install the JPEGCODE included in the application S/W CD-ROM. If not, the movie clip may not play back on the PC.

[Installing the JPEG Decoder]

1) Insert the CD provided with the camera.

2) Run the windows explorer and select the CD-ROM drive.

3) Select the JPEG_Decoder folder and double click the Setup.exe file.

The codec will be installed.

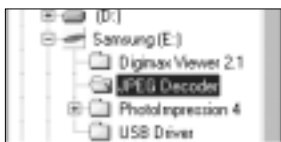

2. Compatible problems with the codecs installed onto the PC.

→ If the movie clip doesn't play back after installing the JPEG Decoder, refer to the following.

FAQ

- 1) When the movie clip plays back, only the sound plays back without the image.
It isn't compatible with the Mogen MJPEG Decoder. Uninstall the Mogen MJPEG Decoder as following order. Click [Start → Run] and a window will open.
Type "regsvr32 /u m3jpgdec.ax" and press the Enter key.



- 2) When the movie clip plays back, the blue and red colors are reversed or the movie clip doesn't open. It isn't compatible with the ffdshow Codec or K-lite Codec Pack.

① Disable the ffdshow program.

Trace [Start → Programs → ffdshow
→ Disable ffdshow].



② Uninstall the K-Lite Codec Pack or set the default program of the AVI file as the Windows Media Player.

Trace [Start → controller panel → Add/ Remove Programs → Select the K-Lite Codec Pack → Click the Change/ Remove button].



Run the windows explorer → Select AVI file →
Click the right mouse button → Select the "Open
with" menu → Click the Windows Media Player →
Check the "Always use this program to open these
files" option → Click the [OK] button.

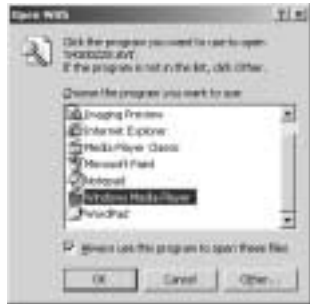

Most problems will be solved with those remedies. If the movie clip doesn't play back continuously, install the JPEGCODE provided with the camera again.

※ For more information, visit the samsung website(www.samsungcamera.com) and see the FAQ page.

MEMO

A large, empty rectangular box with rounded corners, intended for writing a memo. The box is white with a thin black border and occupies most of the page below the header.

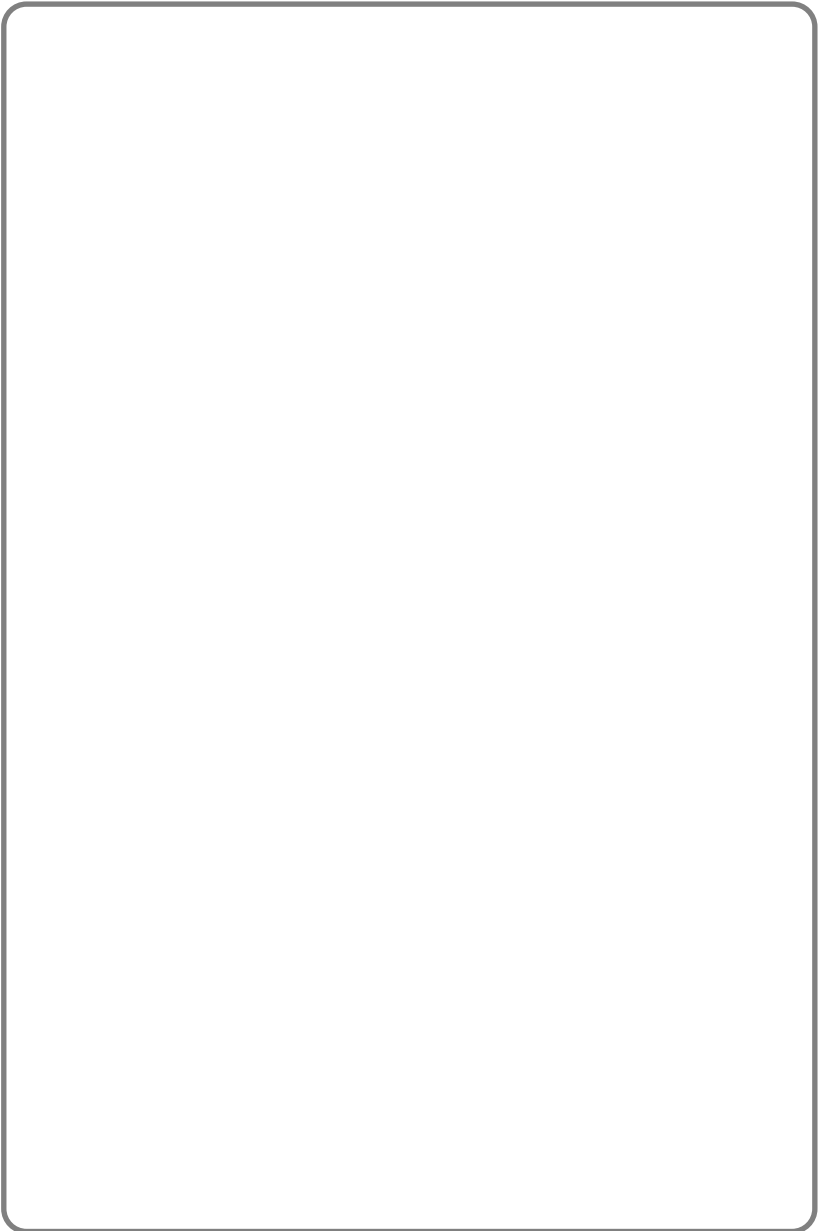



SAMSUNG TECHWIN CO., LTD.
OPTICS & DIGITAL IMAGING DIVISION
145-3, SANGDAEWON 1-DONG, JUNGWON-
GU, SUNGNAM-CITY, KYUNGKI-DO, KOREA
462-121
TEL : (82) 31-740-8086, 8088, 8090, 8092, 8099
FAX : (82) 31-740-8398, 8111

SAMSUNG OPTO-ELECTRONICS AMERICA, INC.
HEADQUARTERS
40 SEAVIEW DRIVE, SECAUCUS, NJ07094, U.S.A.
TEL : (1) 201-902-0347
FAX : (1) 201-902-9342

WESTERN REGIONAL OFFICE
18600 BROADWICK ST.,
RANCHO DOMINGUEZ, CA 90220, U.S.A.
TEL : (1) 310-900-5263/5264
FAX : (1) 310-537-1566

SAMSUNG OPTO-ELECTRONICS UK LIMITED
SAMSUNG HOUSE
1000 HILLSWOOD DRIVE
HILLSWOOD BUSINESS PARK
CHERTSEY KT16 OPS U.K.
TEL : +44 (0) 1932 455300
FAX : +44 (0) 1932 455325

SAMSUNG OPTO-ELECTRONICS GMBH
AM KRONBERGER HANG 6
D-65824 SCHWALBACH/TS., GERMANY
TEL : (49) 6196 66 53 03
FAX : (49) 6196 66 53 66

SAMSUNG FRANCE S.A.S.
BP 51 TOUR MAINE MONTPARNASSE
33, AV. DU MAINE
75755, PARIS CEDEX 15, FRANCE
HOTLINE PHOTO NUMÉRIQUE :
00 800 22 26 37 27 (Numéro Vert-Appel Gratuit)
TEL : (33) 1-4279-2282/5
FAX : (33) 1-4320-4510

SAMSUNG TECHWIN MOSCOW OFFICE
RUSSIA, 125167, MOSCOW LENNINGRADSKY,
PR-KT, 37-A, KORP14
TEL : (7) 095-258-9299/96/98
FAX : (7) 095-258-9297
<http://www.samsungcamera.ru>

TIANJIN SAMSUNG OPTO-ELECTRONICS CO.,LTD.
7 PINGCHANG ROAD NANKAI DIST., TIANJIN
P.R CHINA
POST CODE:300190
TEL : (86) 22-2761-8867
FAX : (86) 22-2761-8864

* Internet address - <http://www.samsungcamera.com/>



The CE Mark is a Directive conformity
mark of the European Community (EC)

6806-1904